



( )  
 Yuekchun Const. Co. Ltd  
 TEL +82 22691 6000  
 FAX +82 22691 6001  
 Web : y6000.co.kr  
 E - mail1 : yccglobal@gmail.com  
 E - mail2 : y6000@paran.com

# TR-600XXL-4

60 Ton Capacity (54.4 Metric Tons)

## HYDRAULIC ROUGH TERRAIN CRANE

### DIMENSIONS

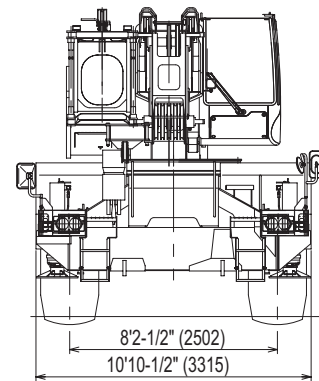
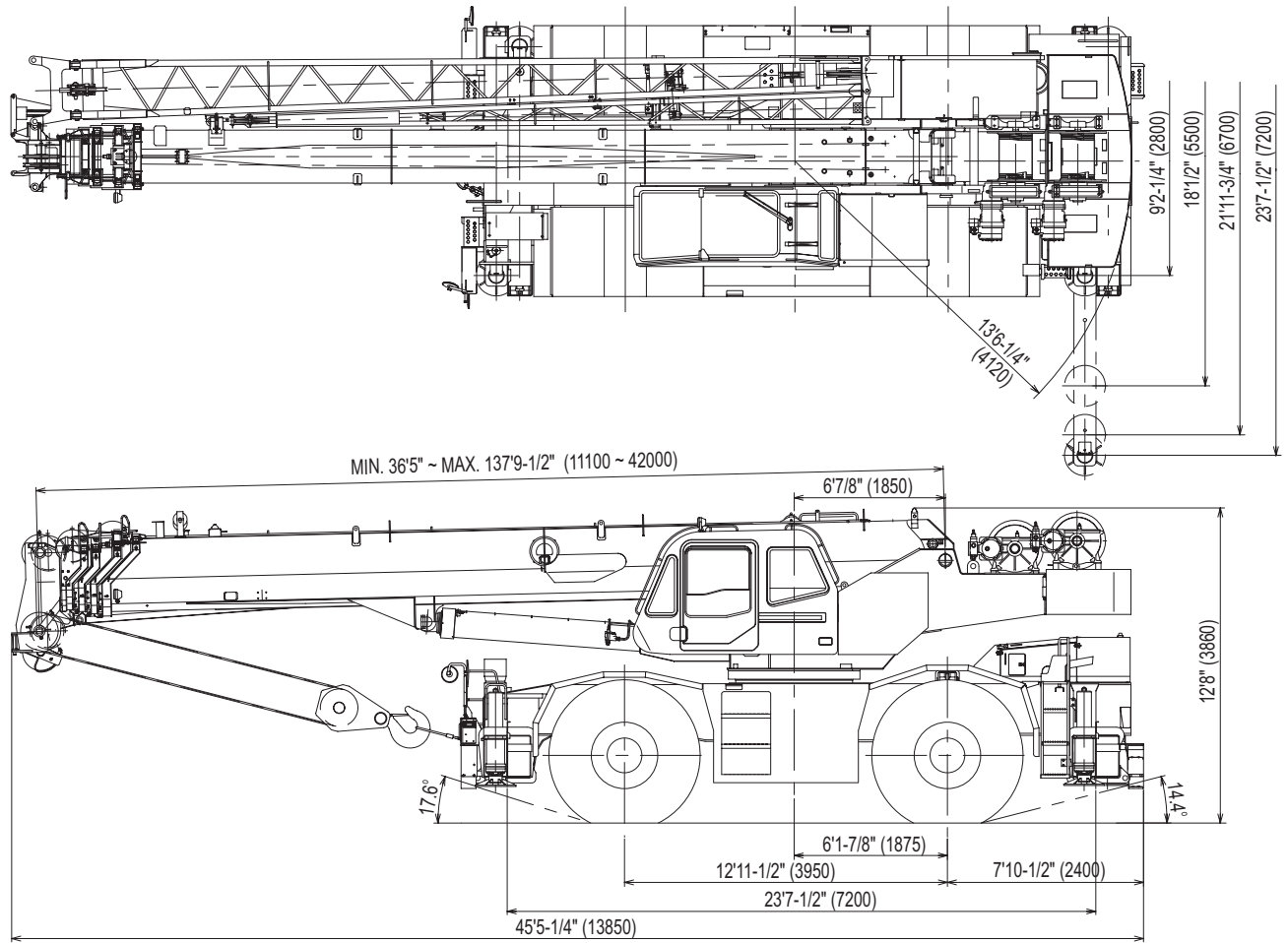

### GENERAL DIMENSIONS (29.5 X 25 Tires)

	Feet	Meters
Turning radius		
4 wheel steer	21'11-3/4"	6.7
2 wheel steer	39'1/2"	11.9

# CRANE SPECIFICATIONS

## BOOM

Five section full power synchronized telescoping boom, 36.4'-137.8' (11.1m-42.0m), of round hexagonal box construction with five sheaves, 17-5/16" (0.44m) root diameter, at boom head. The synchronization system consists of two telescope cylinders, an extension cable and retraction cable. Hydraulic cylinder fitted with holding valve. Two easily removable wire rope guards, rope dead end provided on both sides of boom head. Boom telescope sections are supported by wear pads both vertically and horizontally.

Extension speed 101.4' in 128 seconds.

**BOOM ELEVATION** - By a double acting hydraulic cylinder with holding valve. Elevation -1.4°-80.5°, combination controls for hand or foot operation. Boom angle indicator. Automatic speed reduction and soft stop function. Elevation speed -1.4°-80.5° in 77 seconds.

**JIB** - Two stage bi-fold lattice type with 3.5°, 25° or 45° offset (tilt type). Single sheave, 15-5/8" (0.396m) root diameter, at the head of both jib sections. Stored alongside base boom section. Jib length is 32.5' (9.9m) or 58.1' (17.7m). Assist cylinders for mounting and stowing are controlled at right side of superstructure. Self stowing jib mounting pins.

**AUXILIARY LIFTING SHEAVE (SINGLE TOP)**  
Single sheave, 15-5/8" (0.396m) root diameter. Mounted to main boom head for single line work (stowable).

**ANTI-TWO BLOCK** - Pendant type over-winding cut out device with audio-visual (FAILURE lamp/BUZZER) warning system.

**SWING**  
Hydraulic axial piston motor driven through planetary swing speed reducer. Continuous 360° full circle swing on ball bearing turntable at 2.5rpm. Equipped with manually locked/released swing brake. 360° positive swing lock for pick and carry and travel modes, manually engaged in cab. Twin swing System: Free swing or lock swing controlled by selector switch on front console. Automatic speed reduction and soft stop function.

## HOIST

**MAIN HOIST** - Variable speed type with grooved drum driven by hydraulic axial piston motor through winch speed reducer. Power load lowering and raising. Equipped with automatic brake (neutral brake) and counterbalance valve. Controlled independently of main hoist. Equipped with cable follower and drum rotation indicator.

**DRUM** - Grooved 15-3/4" (0.40m) root diameter x 22-3/4" (0.578m) wide. Wire rope: 745' of 3/4" diameter rope (227m of 19mm). Drum capacity: 1,096' (334m) 7 layers. Maximum line pull (permissible): 15,200lbs. (6,880kg)\*. Maximum line speed: 585FPM (178m/min).

**AUXILIARY HOIST** - Variable speed type with grooved drum driven by hydraulic axial piston motor through winch speed reducer. Power load lowering and raising. Equipped with automatic brake (neutral brake) and counterbalance valve. Controlled independently of main hoist. Equipped with cable follower and drum rotation indicator.

**DRUM** - Grooved 15-3/4" (0.40m) root diameter x 22-3/4" (0.578m) wide. Wire rope: 436' of 3/4" diameter rope (133m of 19mm). Drum capacity: 1,096' (334m) 7 layers. Maximum line pull (permissible): 15,200lbs. (6,880kg)\*. Maximum line speed: 585FPM (178m/min).

\*Maximum permissible line pull may be affected by wire rope strength.

**WIRE ROPE** - Warrington seal wire, extra improved plow steel, preformed, independent wire rope core, right regular lay. 3/4" (19 mm) 6X37 class

## HOOK BLOCKS

60 ton (54.4 metric ton) - 5 sheaves with swivel hook and safety latch, for 3/4" (19mm) wire rope. (OPTIONAL)  
6.2 ton (5.6 metric ton) - Weighted hook with swivel and safety latch, for 3/4" (19mm) wire rope.

## HYDRAULIC SYSTEM

**PUMPS** - Two variable piston pumps for crane functions. Tandem gear pump for steering, swing and optional equipment. Powered by carrier engine. Pump disconnect for crane is engaged/ disengaged by rotary switch from operator's cab.

**CONTROL VALVES** - Multiple valves actuated by pilot pressure with integral pressure relief valves.

**RESERVOIR** - 195 gallon (740 lit.) capacity. External sight level gauge.

**FILTRATION** - 26 micron return filter, full flow with bypass protection, located inside of hydraulic reservoir. Accessible for easy replacement.

**OIL COOLER** - Air cooled fan type.

## CAB AND CONTROLS

Both crane and drive operations can be performed from one cab mounted on rotating superstructure.

Left side, 1 man type, steel construction with sliding door access and tinted safety glass windows opening at side. Door window is powered control. Windshield glass and roof window glass are shatter-resistant. Tilt-telescoping steering wheel. Adjustable control lever stands for swing, boom hoist, boom telescoping, auxiliary hoist and main hoist. Control lever stands can change neutral positions and tilt for easy access into cab. 3 way adjustable operator's seat with high back, headrest and armrest. Engine throttle knob. Foot operated controls: boom hoist, boom telescoping, service brake and engine throttle. Hot water cab heater and air conditioning (OPTIONAL).

Dash-mounted engine start/stop, monitor lamps, cigarette lighter ashtray, drive selector switch, parking brake switch, steering mode select switch, power window switch, pump engaged/ disengaged switch, swing brake switch, telescoping/auxiliary winch select switch, outrigger controls, main winch/auxiliary winch selector switch, swing stop cancel switch, slow elevation stop cancel switch and free swing / lock swing selector switch.

Instruments - Torque converter oil temperature, engine water temperature, air pressure, fuel, speedometer, tachometer and hour meter. Hydraulic oil pressure is monitored and displayed on the AML-L display panel.

- Tadano electronic LOAD MOMENT INDICATOR system (AML-L) including:
- Control lever lockout function with audible and visual pre-warning.
  - Lift status indicator
  - Outrigger status indicator
  - Boom angle / boom length / jib offset angle / load radius / rated lifting capacities / actual loads read out
  - Ratio of actual load moment to rated load moment indication
  - Automatic Speed Reduction and Soft Stop function on boom elevation and swing
  - Working condition register switch
  - Load radius / boom angle / tip height / swing range preset function
  - External warning lamp

TADANO AML-L monitors outrigger extended length and automatically programs the corresponding "RATED LIFTING CAPACITIES" table.

Operator's right hand console includes transmission gear selector and sight level bubble. Upper console includes working light switch, roof washer and wiper switch, oil cooler switch, emergency outrigger set up key switch, drum indicator switch, jib equipped/removed select switch, boom emergency telescoping switch (2nd and 3rd-top) and air conditioning control switch. Swing lock lever.

NOTE: Each crane motion speed is based on unladen conditions.

## CARRIER SPECIFICATIONS

**TYPE** - Rear engine, left hand steering, driving axle 2-way selected type by manual switch, 4x2 front drive, 4x4 front and rear drive.

**FRAME** - High tensile steel, all welded mono-box construction.

**TRANSMISSION** - Electronically controlled full automatic transmission. Torque converter driving full powershift with driving axle selector. 6 forward and 2 reverse speeds, constant mesh.

- 3 speeds - high range - 2 wheel drive; 4 wheel drive
- 3 speeds - low range - 4 wheel drive

**TRAVEL SPEED** - 25 mph (40 km/h)

**AXLE** - Front: Full floating type, steering and driving axle with planetary reduction. Rear: Full floating type, steering and driving axle with planetary reduction and non-spin rear differential.

**STEERING**- Hydraulic power steering controlled by steering wheel. Four steering modes available: 2 wheel front, 2 wheel rear, 4 wheel coordinated and 4 wheel crab .

**SUSPENSION** - Front: Rigid mounted to frame. Rear: Pivot mounted with hydraulic lockout device.

**BRAKE SYSTEMS** - Service: Air over hydraulic disc brakes on all 4 wheels. Parking/Emergency: Spring applied-air released brake acting on input shaft of front axle. Auxiliary: Electro-pneumatic operated exhaust brake.

**TIRES** - 29.5-25 22PR(OR)

**OUTRIGGERS** - Four hydraulic, beam and jack outriggers. Vertical jack cylinders equipped with integral holding valve. Each outrigger beam and jack is controlled independently from cab. Beams extend to 23' 7-1/2" (7.2 m) center-line and retract to within 10' 10-1/2" (3.315 m) overall width with floats. Outrigger jack floats are attached thus eliminating the need of manually attaching and detaching them. Controls and sight bubble located in superstructure cab. Four outrigger extension lengths are provided with corresponding "RATED LIFTING CAPACITIES" for crane duty in confined areas. Both symmetrical and Non-symmetrical outrigger extension (deployment) is permitted.

- Min. Extension 9' 2-1/4" center to center
- Mid. Extension 18' 1/2" center to center
- Mid. Extension 21' 11-3/4" center to center
- Max. Extension 23' 7-1/2" center to center

Float size(Diameter) 1' 7-11/16" (0.5m)

### ENGINE

Model	Mitsubishi 6D16-TLEE
Type	Direct injection diesel
No. of cylinders	6
Combustion	4 cycle, turbo charged and after cooled
BoreXStroke, in.(mm)	4.646 X 4.528 (118X115)
Displacement, cu. in (liters)	460 (7.545)
Air inlet heater	24 volt preheat
Air cleaner	Dry type, replaceable element
Oil filter	Full flow with replaceable element
Fuel filter	Full flow with replaceable element
Fuel tank, gal.(liters)	79.2 (300), right side of carrier
Cooling	Liquid pressurized, recirculating by-pass

Radiator	Fin and tube core, thermostat controlled
Fan, in.(mm)	Suction type, 6-blade, 23.6 (600) dia.
Starting	24 volt
Charging	24 volt system, negative ground
Battery	2-120 amp. Hour
Compressor, air, CFM(l /min)	9.2 CFM (260) at 2,800rpm
Horsepower (kW)	Gross 223 (166) at 2,700rpm
Torque, Max. ft-lb (kgm)	521 (72) at 1,300rpm
Capacity, gal.(liters)	
Cooling water	3.4 (13)
Lubrication	3.7 ~ 4.2 (14 ~ 16)
Fuel	79.2 (300)

## STANDARD EQUIPMENT

- Five section full power partially synchronized boom 36.4'~137.8' (11.1 m~42.0 m)
- 32.5'~58.1' (9.9 m~17.7 m) bi-fold lattice jib (tilt type) with 3.5°, 25° or 45° pinned offsets and self storing pins.
- Auxiliary lifting sheave (single top) stowable
- Variable speed main hoist with grooved drum, cable follower and 745' of 3/4" cable.
- Variable speed auxiliary hoist with grooved drum, cable follower and 436' of 3/4" cable.
- Drum rotation indicator (thumper type) main and auxiliary hoist
- Anti-Two block device (overwind cutout)
- Boom angle indicator
- Tadano electronic load moment indicator system (AML-L)
- Outrigger extension length detector
- Electronic crane monitoring system
- Tadano twin swing system and 360° positive swing lock
- Self centering finger control levers with pilot control
- Control pedals for boom hoist and boom telescoping
- 3 way adjustable cloth seat with armrests, high back and seat belt
- Tilt-telescoping steering wheel
- Tinted safety glass and sun visor
- Front windshield wiper and washer
- Roof window wiper and washer
- Power window (cab door)
- Rear view mirrors (right and left side)
- Mirror for main and auxiliary hoists
- Cigarette lighter and ashtray
- Electric fan in cab
- Cab floor mat
- Pump disconnect in operator's cab
- Hydraulic oil cooler
- Independently controlled outriggers
- Four outrigger extension positions
- Self-storing outrigger pads
- Outrigger hose protection
- Mitsubishi 6D16-TLEE turbo charged after cooled engine (223HP) with exhaust brake
- Electronic controlled automatic transmission driven by torque converter
- 4 X 4 X 4 drive/steer
- Non-spin rear differential
- Automatic rear axle oscillation lockout system
- 29.5-25 22PR (OR) tires
- Disc brakes
- Fenders
- Air dryer
- Water separator with filter
- Engine over-run alarm
- Back-up alarm
- Low oil pressure/high water temp. warning device (visual)
- Rear steer centering light
- Air cleaner dust indicator
- Full instrumentation package
- Complete highway light package
- Work lights
- Tool storage compartment
- Tire inflation kit
- 24 volt electric system
- 6.2 ton (5.6 metric ton) hook with swivel
- Towing hooks-Front and rear
- Lifting eyes
- Hook block tie down (front bumper)
- Weighted hook storage compartment

## OPTIONAL EQUIPMENT

- 60 ton (54.4 metric ton) 5 sheaves hook block
- Hot water cab heater and air conditioner

## HOISTING PERFORMANCE

### LINE SPEEDS AND PULLS

Layer	Speed	Main or auxiliary hoist - 15'-3/4" (0.4m) drum					
		Line speeds <sup>2</sup>		Line pulls			
		F.P.M	m/min	Available <sup>1</sup>		Permissible <sup>4</sup>	
				Lbs.	kgf	Lbs.	kgf
1st	High	378	115	18,200	8,260	15,200	6,880
2nd	High	413	126	16,700	7,570	13,900	6,310
3rd	High	448	136	15,400	6,990	12,800	5,820
4th	High	482	147	14,300	6,490	11,900	5,410
5th	High	502	157	13,400	6,060	11,100	5,050
6th <sup>3</sup>	High	551	168	12,500	5,680	10,400	4,730
7th <sup>3</sup>	High	585	178	11,800	5,350	9,800	4,460

<sup>1</sup> Developed by machinery with each layer of wire rope, but not based on rope strength or other limitation in machinery or equipment.

<sup>2</sup> Line speeds based only on hook block, not loaded.

<sup>3</sup> Sixth layer and seventh layer of wire rope are not recommended for hoisting operations.

<sup>4</sup> Permissible line pull may be affected by wire rope strength.

### DRUM WIRE ROPE CAPACITIES

Wire rope layer	Main and auxiliary drum grooved lagging			
	3/4" (19mm) wire rope			
	Rope per layer		Total wire rope	
	Feet	Meters	Feet	Meters
1	123.0	37.5	123.0	37.5
2	134.2	40.9	257.2	78.4
3	145.3	44.3	402.6	122.7
4	156.5	47.7	559.1	170.4
5	167.7	51.1	726.7	221.5
6	178.8	54.5	905.5	276.0
7	190.0	57.9	1,095.5	333.9

### DRUM DIMENSIONS

	Inch	mm
Root diameter	15-3/4"	400
Length	22-3/4"	578
Flange diameter	27-3/8"	695

# TR-600XXL-4 WORKING RANGE CHART

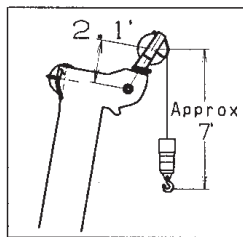
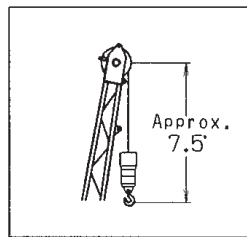
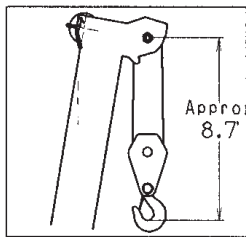
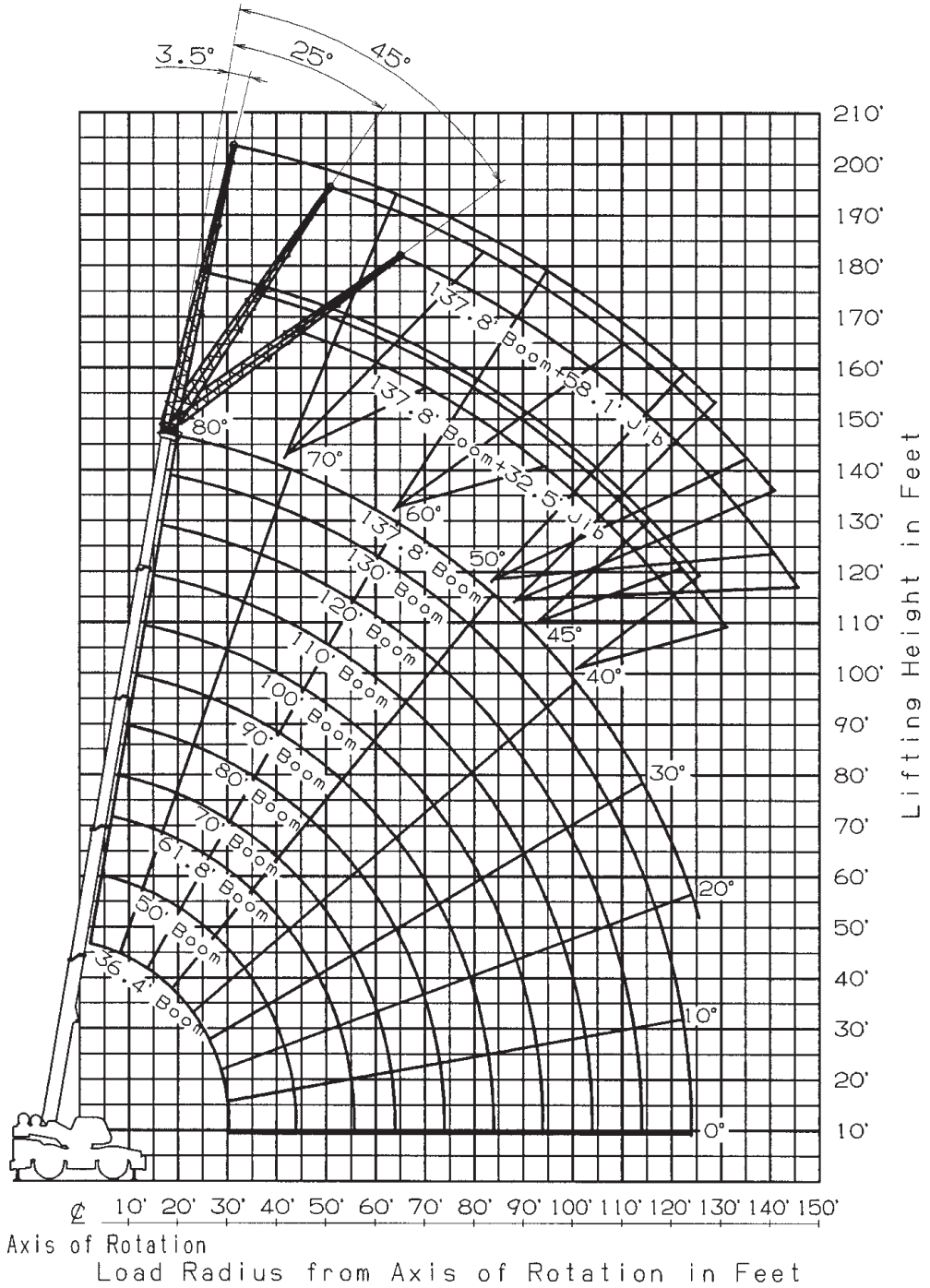

Boom Length in Feet

36.4'	(11.1m)
50'	(15.24m)
61.8'	(18.83m)
90'	(27.43m)
110'	(33.53m)
137.8'	(42.0m)

NOTE: Boom and jib geometry shown are for unloaded condition and machine standing level on firm supporting surface. Boom deflection and subsequent radius and boom angle change must be accounted for when applying load to hook.

# TR-600XXL-4 RATED LIFTING CAPACITIES (IN POUNDS)

ON OUTRIGGERS FULLY EXTENDED 23' 7-1/2"(7.2m) SPREAD												
360° ROTATION												
A \ B	36.4'		50'		61.8'		70'		80'		90'	
	C	(11.1m)	C	(15.24m)	C	(18.83m)	C	(21.34m)	C	(24.38m)	C	(27.43m)
10	67.0	120,000	73.6	90,000	77.2	62,000	78.9	44,100				
12	63.5	107,000	71.2	90,000	75.3	62,000	77.2	44,100	79.2	44,100		
15	57.8	88,200	67.6	90,000	72.5	62,000	74.8	44,100	77.1	44,100	78.9	44,100
20	47.5	67,200	61.0	65,300	67.6	56,800	70.6	44,100	43.6	44,100	75.9	42,900
25	34.8	52,000	54.0	51,800	62.3	46,900	66.3	43,600	69.8	39,600	72.6	35,600
30	12.0	41,900	46.3	40,300	56.8	38,700	61.5	36,200	65.8	33,300	69.2	30,300
35			37.3	31,700	50.8	31,200	56.6	29,700	61.7	28,000	65.6	26,200
40			25.4	24,100	44.3	23,600	51.3	23,400	57.4	23,100	61.9	22,900
45					36.6	18,300	45.5	18,900	52.8	19,600	58.2	20,300
50					27.2	14,400	39.1	15,200	47.9	16,200	54.1	17,200
55					11.6	11,400	31.7	12,200	42.6	13,200	49.8	14,200
60							21.7	9,700	36.6	10,700	45.2	11,700
65									29.7	8,700	40.2	9,700
70									20.4	7,100	34.8	8,100
75											28.2	6,700
80											19.6	5,600
D	0°											

LIFTING CAPACITIES AT ZERO DEGREE BOOM ANGLE ON OUTRIGGERS												
FULLY EXTENDED 23' 7-1/2"(7.2m) SPREAD 360° ROTATION												
A \ C	36.4'		50'		61.8'		70'		80'		90'	
	B	(11.1m)	B	(15.24m)	B	(18.83m)	B	(21.34m)	B	(24.38m)	B	(27.43m)
0°	30.3	41,200	43.9	19,500	55.7	11,000	63.9	8,100	73.9	6,000	83.9	4,800

ON OUTRIGGERS FULLY EXTENDED 23' 7-1/2"(7.2m) SPREAD										
360° ROTATION										
A \ B	100'		110'		120'		130'		137.8'	
	C	(30.48m)	C	(33.53m)	C	(36.58m)	C	(39.62m)	C	(42m)
15	80.0	36,600								
20	77.5	36,000	78.7	29,000	79.8	24,900				
25	74.6	32,300	76.1	29,000	77.5	24,900	78.7	20,800	79.4	17,600
30	71.5	27,900	73.6	25,400	75.1	22,600	76.5	19,800	77.6	17,600
35	68.4	24,300	70.8	22,300	72.6	20,400	74.4	18,600	75.6	17,100
40	65.2	21,300	67.8	19,600	70.0	18,000	72.1	16,400	73.3	15,200
45	62.0	18,900	65.0	17,400	67.4	16,000	69.6	14,600	71.2	13,500
50	58.4	16,400	62.0	15,500	64.7	14,300	67.2	13,100	68.8	12,100
55	54.9	14,100	58.9	14,000	62.0	12,900	64.7	11,800	66.5	10,900
60	51.2	12,200	55.8	12,600	59.1	11,600	62.2	10,600	64.1	9,800
65	47.1	10,200	52.4	10,600	56.2	10,000	59.5	9,400	61.8	8,900
70	42.7	8,600	48.8	9,000	53.0	8,700	56.8	8,400	59.3	8,200
75	38.2	7,200	45.1	7,600	49.9	7,500	54.0	7,500	56.6	7,400
80	32.8	6,000	41.0	6,400	46.5	6,500	51.0	6,700	54.0	6,800
85	26.6	5,000	36.6	5,400	42.8	5,700	47.9	5,900	51.3	6,100
90	18.7	4,100	31.6	4,500	38.7	4,800	44.6	5,000	48.3	5,200
95			25.9	3,800	34.7	4,100	41.1	4,300	45.2	4,500
100			18.3	3,100	29.6	3,400	37.2	3,600	41.6	3,800
105					23.8	2,800	33.1	3,000	38.4	3,200
110					16.7	2,200	28.5	2,400	34.6	2,600
115							22.3	1,900	30.9	2,100
120							15.7	1,500	26.0	1,700
125									21.0	1,300
D	0°					18°				

LIFTING CAPACITIES AT ZERO DEGREE BOOM ANGLE ON OUTRIGGERS								
FULLY EXTENDED 23' 7-1/2"(7.2m) SPREAD 360° ROTATION								
A \ C	100'		110'		120'		130'	
	B	(30.48m)	B	(33.53m)	B	(36.58m)	B	(39.62m)
0°	93.9	3,600	103.9	2,700	113.9	1,800	123.9	1,200

- A : Boom length in feet
- B : Load radius in feet
- C : Loaded boom angle (deg.)
- D : Minimum boom angle (deg.) for indicated length (no load)

# TR-600XXL-4 RATED LIFTING CAPACITIES (IN POUNDS)

ON OUTRIGGERS FULLY EXTENDED 23' 7-1/2"(7.2m) SPREAD 360° ROTATION													
C	137.8' (42.0m) Boom + 32.5' (9.9m) Jib						C	137.8' (42.0m) Boom + 58.1' (17.7m) Jib					
	3.5° Tilt		25° Tilt		45° Tilt			3.5° Tilt		25° Tilt		45° Tilt	
	R	W	R	W	R	W		R	W	R	W	R	W
80°	30.9	8,800	43.2	7,800	50.9	6,500	80°	39.4	5,900	59.2	4,500	72.8	3,100
77.5°	39.0	8,800	50.7	7,200	57.7	6,000	77.5°	49.0	5,800	67.3	4,000	80.0	3,000
75°	47.0	8,800	57.8	6,600	64.3	5,500	75°	58.7	5,800	75.0	3,600	87.4	2,800
72.5°	54.3	7,800	64.9	5,900	70.5	5,000	72.5°	66.7	5,000	82.6	3,200	94.8	2,600
70°	61.4	6,900	71.2	5,300	76.7	4,600	70°	74.3	4,300	90.6	2,900	102.0	2,400
67.5°	68.2	6,100	78.0	4,800	82.8	4,300	67.5°	82.3	3,800	98.0	2,700	109.0	2,300
65°	74.8	5,400	84.0	4,300	88.5	3,900	65°	89.6	3,300	106.0	2,400	116.0	2,100
62.5°	81.5	4,900	90.4	3,900	94.5	3,600	62.5°	96.9	2,900	112.0	2,200	122.0	1,900
60°	88.1	4,400	96.8	3,600	100.0	3,300	60°	104.0	2,600	119.0	2,000	128.0	1,800
57.5°	94.2	4,000	103.0	3,300	106.0	3,100	57.5°	112.0	2,300	125.0	1,800	133.0	1,700
55°	100.0	3,600	109.0	3,100	112.0	2,900	55°	118.0	2,100	131.0	1,600	137.0	1,500
52.5°	106.0	3,300	114.0	2,800	117.0	2,700	52.5°	125.0	1,900	136.0	1,500	142.0	1,400
50°	112.0	3,000	120.0	2,600	123.0	2,500	50°	131.0	1,700	142.0	1,400	146.0	1,300
47.5°	117.0	2,400	125.0	2,100	127.0	2,100	47.5°	137.0	1,300	147.0	1,100	150.0	1,000
45°	122.0	1,900	129.0	1,700	131.0	1,700							
42.5°	126.0	1,500	134.0	1,300									
40°	131.0	1,100	138.0	1,000									

ON OUTRIGGERS FULLY EXTENDED 23' 7-1/2"(7.2m) SPREAD 360° ROTATION													
C	110' (33.53m) Boom + 32.5' (9.9m) Jib						C	110' (33.53m) Boom + 58.1' (17.7m) Jib					
	3.5° Tilt		25° Tilt		45° Tilt			3.5° Tilt		25° Tilt		45° Tilt	
	R	W	R	W	R	W		R	W	R	W	R	W
80°	24.4	12,300	36.2	11,000	43.5	8,000	80°	32.2	7,900	53.0	5,700	65.8	3,800
77.5°	30.9	12,300	42.3	10,100	49.0	7,600	77.5°	39.9	7,900	60.2	5,200	71.8	3,600
75°	37.4	12,300	48.3	9,300	54.7	7,200	75°	48.3	7,900	67.1	4,800	77.3	3,500
72.5°	43.8	11,800	54.2	8,600	59.7	6,800	72.5°	55.8	7,500	73.5	4,500	83.3	3,400
70°	49.8	11,200	59.7	8,000	64.9	6,500	70°	62.8	7,100	80.1	4,200	89.2	3,200
67.5°	55.5	10,000	65.1	7,400	70.0	6,200	67.5°	69.5	6,300	86.1	4,000	94.2	3,100
65°	60.8	9,000	70.6	6,900	74.8	6,000	65°	75.7	5,600	92.3	3,700	99.5	3,000
62.5°	66.7	8,200	75.7	6,400	79.8	5,700	62.5°	82.1	5,100	98.0	3,500	104.0	2,900
60°	72.2	7,500	80.7	6,000	84.2	5,400	60°	88.3	4,600	104.0	3,300	109.0	2,800
57.5°	77.2	6,900	85.5	5,600	88.6	5,100	57.5°	94.3	4,300	109.0	3,200	114.0	2,750
55°	82.4	6,400	90.1	5,300	92.9	4,900	55°	100.0	3,900	114.0	3,000	118.0	2,700
52.5°	87.4	6,000	94.6	5,000	96.9	4,700	52.5°	106.0	3,600	119.0	2,800	122.0	2,600
50°	91.8	5,500	99.0	4,800	101.0	4,500	50°	111.0	3,300	124.0	2,700	126.0	2,500
47.5°	96.0	4,800	103.0	4,200	104.0	4,000	47.5°	116.0	3,000	128.0	2,500	130.0	2,400
45°	100.0	4,100	107.0	3,700	108.0	3,600	45°	121.0	2,800	132.0	2,400	134.0	2,300
42.5°	104.0	3,600	110.0	3,300			42.5°	126.0	2,300	136.0	2,000		
40°	108.0	3,100	114.0	2,900			40°	130.0	1,900	139.0	1,600		
37.5°	111.0	2,700	117.0	2,500			37.5°	134.0	1,600	143.0	1,300		
35°	115.0	2,300	120.0	2,200			35°	138.0	1,300	146.0	1,100		
32.5°	118.0	2,000	122.0	1,900			32.5°	142.0	1,000				
30°	121.0	1,800	125.0	1,700									
27.5°	124.0	1,500	127.0	1,500									
25°	126.0	1,300	129.0	1,300									
22.5°	129.0	1,100											
20°	130.0	1,000											

**C** :Loaded boom angle (deg.)  
**R** :Load radius in feet  
**W** :Rated lifting capacity in pounds

# TR-600XXL-4 RATED LIFTING CAPACITIES (IN POUNDS)

ON OUTRIGGERS MID EXTENDED 21' 11-3/4"(6.7m) SPREAD												
360° ROTATION												
A \ B	36.4'		50'		61.8'		70'		80'		90'	
	C	(11.1m)	C	(15.24m)	C	(18.83m)	C	(21.34m)	C	(24.38m)	C	(27.43m)
10	67.0	120,000	73.6	90,000	77.2	62,000	78.9	44,100				
12	63.5	107,000	71.2	90,000	75.3	62,000	77.2	44,100	79.2	44,100		
15	57.8	88,200	67.6	90,000	72.5	62,000	74.8	44,100	77.1	44,100	78.9	44,100
20	47.5	67,200	61.0	65,300	67.6	56,800	70.6	44,100	43.6	44,100	75.9	42,900
25	34.8	50,500	54.0	48,000	62.3	46,900	66.3	43,600	69.8	39,600	72.6	35,600
30	11.8	34,000	46.3	35,100	56.8	34,400	61.5	33,200	65.8	31,800	69.2	30,300
35			37.2	25,800	50.8	25,300	56.5	25,600	61.6	25,900	65.6	26,200
40			25.3	19,500	44.3	19,000	51.1	19,500	57.3	20,200	61.9	20,800
45					36.6	14,600	45.4	15,100	52.7	15,800	58.0	16,400
50					27.2	11,300	39.0	11,900	47.8	12,500	53.9	13,200
55					11.5	8,800	31.5	9,400	42.5	10,100	49.6	10,800
60							21.6	7,400	36.5	8,100	45.1	8,800
65									29.5	6,500	40.1	7,200
70									20.3	5,100	34.6	5,800
75											28.0	4,700
80											19.5	3,800
D	0°											

LIFTING CAPACITIES AT ZERO DEGREE BOOM ANGLE ON OUTRIGGERS												
MID EXTENDED 21' 11-3/4"(6.7m) SPRED 360° ROTATION												
A \ C	36.4'		50'		61.8'		70'		80'		90'	
	B	(11.1m)	B	(15.24m)	B	(18.83m)	B	(21.34m)	B	(24.38m)	B	(27.43m)
0°	30.3	33,400	43.9	15,600	55.7	8,500	63.9	6,100	73.9	4,200	83.9	3,200

ON OUTRIGGERS MID EXTENDED 21' 11-3/4"(6.7m) SPREAD											
360° ROTATION											
A \ B	100'		110'		120'		130'		137.8'		
	C	(30.48m)	C	(33.53m)	C	(36.58m)	C	(39.62m)	C	(42m)	
15	80.0	36,600									
20	77.5	36,000	78.7	29,000	79.8	24,900					
25	74.6	32,300	76.1	29,000	77.5	24,900	78.7	20,800	79.4	17,600	
30	71.5	27,900	73.6	25,400	75.1	22,600	76.5	19,800	77.6	17,600	
35	68.4	24,300	70.8	22,300	72.6	20,400	74.4	18,600	75.6	17,100	
40	65.2	20,200	67.8	19,600	70.0	18,000	72.1	16,400	73.3	15,200	
45	61.8	16,900	65.0	17,400	67.4	16,000	69.6	14,600	71.2	13,500	
50	58.2	13,700	61.9	14,100	64.7	13,400	67.2	12,700	68.8	12,100	
55	54.7	11,200	58.8	11,600	61.8	11,300	64.7	11,100	66.5	10,900	
60	50.9	9,200	55.6	9,600	58.8	9,700	62.0	9,700	64.1	9,800	
65	47.0	7,600	52.2	8,000	56.0	8,300	59.4	8,500	61.8	8,700	
70	42.7	6,200	48.6	6,600	52.9	6,900	56.6	7,100	59.0	7,300	
75	37.9	5,100	44.9	5,500	49.6	5,800	53.7	6,000	56.1	6,200	
80	32.7	4,200	40.8	4,500	46.2	4,800	50.7	5,000	53.8	5,200	
85	26.5	3,400	36.3	3,700	42.5	4,000	47.6	4,200	50.8	4,400	
90	18.3	2,700	31.4	3,000	38.5	3,200	44.2	3,400	47.9	3,600	
95			25.5	2,400	34.4	2,600	40.8	2,800	44.7	3,000	
100			18.1	1,800	29.5	2,000	36.9	2,200	41.4	2,400	
105					23.7	1,500	33.0	1,700	38.1	1,900	
110									34.3	1,500	
D	0°			17°			28°		33°		

LIFTING CAPACITIES AT ZERO DEGREE BOOM ANGLE ON OUTRIGGERS				
MID EXTENDED 21' 11-3/4"(6.7m) SPRED 360° ROTATION				
A \ C	100'		110'	
	B	(30.48m)	B	(33.53m)
0°	93.9	2,200	103.9	1,400

- A : Boom length in feet
- B : Load radius in feet
- C : Loaded boom angle (deg.)
- D : Minimum boom angle (deg.) for indicated length (no load)



# TR-600XXL-4 RATED LIFTING CAPACITIES (IN POUNDS)

ON OUTRIGGERS MID EXTENDED 21' 11-3/4"(6.7m) SPREAD 360° ROTATION													
C	137.8' (42.0m) Boom + 32.5' (9.9m) Jib						C	137.8' (42.0m) Boom + 58.1' (17.7m) Jib					
	3.5° Tilt		25° Tilt		45° Tilt			3.5° Tilt		25° Tilt		45° Tilt	
	R	W	R	W	R	W		R	W	R	W	R	W
80°	30.9	8,800	43.2	7,800	50.9	6,500	80°	39.4	5,900	59.2	4,500	72.8	3,100
77.5°	39.0	8,800	50.7	7,200	57.7	6,000	77.5°	49.0	5,800	67.3	4,000	80.0	3,000
75°	47.0	8,800	57.8	6,600	64.3	5,500	75°	58.7	5,800	75.0	3,600	87.4	2,800
72.5°	54.3	7,800	64.9	5,900	70.5	5,000	72.5°	66.7	5,000	82.6	3,200	94.8	2,600
70°	61.4	6,900	71.2	5,300	76.7	4,600	70°	74.3	4,300	90.6	2,900	102.0	2,400
67.5°	68.2	6,100	78.0	4,800	82.8	4,300	67.5°	82.3	3,800	98.0	2,700	109.0	2,300
65°	74.8	5,400	84.0	4,300	88.5	3,900	65°	89.6	3,300	106.0	2,400	116.0	2,100
62.5°	81.5	4,900	90.4	3,900	94.5	3,600	62.5°	96.9	2,900	112.0	2,200	122.0	1,900
60°	88.1	4,400	96.8	3,600	100.0	3,300	60°	104.0	2,600	119.0	2,000	128.0	1,800
57.5°	93.7	3,600	102.0	3,000	106.0	2,800	57.5°	111.0	2,100	125.0	1,700	132.0	1,500
55°	99.2	2,800	108.0	2,500	111.0	2,400	55°	118.0	1,700	130.0	1,300	137.0	1,300
52.5°	105.0	2,200	113.0	2,000	116.0	2,000	52.5°	124.0	1,200				
50°	110.0	1,700	118.0	1,500	121.0	1,500							
47.5°	116.0	1,300	123.0	1,100	125.0	1,100							

ON OUTRIGGERS MID EXTENDED 21' 11-3/4"(6.7m) SPREAD 360° ROTATION													
C	110' (33.53m) Boom + 32.5' (9.9m) Jib						C	110' (33.53m) Boom + 58.1' (17.7m) Jib					
	3.5° Tilt		25° Tilt		45° Tilt			3.5° Tilt		25° Tilt		45° Tilt	
	R	W	R	W	R	W		R	W	R	W	R	W
80°	24.4	12,300	36.2	11,000	43.5	8,000	80°	32.2	7,900	53.0	5,700	65.8	3,800
77.5°	30.9	12,300	42.3	10,100	49.0	7,600	77.5°	39.9	7,900	60.2	5,200	71.8	3,600
75°	37.4	12,300	48.3	9,300	54.7	7,200	75°	48.3	7,900	67.1	4,800	77.3	3,500
72.5°	43.8	11,800	54.2	8,600	59.7	6,800	72.5°	55.8	7,500	73.5	4,500	83.3	3,400
70°	49.8	11,200	59.7	8,000	64.9	6,500	70°	62.8	7,100	80.1	4,200	89.2	3,200
67.5°	55.5	10,000	65.1	7,400	70.0	6,200	67.5°	69.5	6,300	86.1	4,000	94.2	3,100
65°	60.8	9,000	70.6	6,900	74.8	6,000	65°	75.7	5,600	92.3	3,700	99.5	3,000
62.5°	66.7	8,200	75.7	6,400	79.8	5,700	62.5°	82.1	5,100	98.0	3,500	104.0	2,900
60°	72.2	7,500	80.7	6,000	84.2	5,400	60°	88.3	4,600	104.0	3,300	109.0	2,800
57.5°	76.9	6,300	85.3	5,300	88.6	5,000	57.5°	94.3	4,100	109.0	3,200	114.0	2,750
55°	81.5	5,200	89.8	4,600	92.9	4,500	55°	99.9	3,500	114.0	3,000	118.0	2,700
52.5°	86.5	4,400	94.1	4,000	96.6	3,900	52.5°	105.0	2,900	119.0	2,500	122.0	2,300
50°	91.0	3,700	98.2	3,400	101.0	3,300	50°	110.0	2,400	123.0	2,000	126.0	1,900
47.5°	95.3	3,100	102.0	2,900	104.0	2,800	47.5°	115.0	1,900	127.0	1,600	130.0	1,600
45°	99.5	2,600	106.0	2,400	108.0	2,400	45°	120.0	1,500	131.0	1,300	133.0	1,300
42.5°	103.0	2,200	110.0	2,100			42.5°	125.0	1,200				
40°	107.0	1,800	113.0	1,700									
37.5°	111.0	1,500	116.0	1,400									
35°	115.0	1,200	119.0	1,100									

**C** :Loaded boom angle (deg.)  
**R** :Load radius in feet  
**W** :Rated lifting capacity in pounds

# TR-600XXL-4 RATED LIFTING CAPACITIES (IN POUNDS)

ON OUTRIGGERS MID EXTENDED 18' 1/2"(5.5m) SPREAD												
360° ROTATION												
B	36.4'		50'		61.8'		70'		80'		90'	
	C	(11.1m)	C	(15.24m)	C	(18.83m)	C	(21.34m)	C	(24.38m)	C	(27.43m)
10	67.0	118,200	73.6	90,000	77.2	62,000	78.9	44,100				
12	63.5	102,400	71.2	90,000	75.3	62,000	77.2	44,100	79.2	44,100		
15	57.8	84,600	67.6	84,000	72.5	62,000	74.8	44,100	77.1	44,100	78.9	44,100
20	47.5	55,400	60.9	54,500	67.5	54,000	70.6	44,100	43.6	44,100	75.9	42,900
25	34.8	36,100	53.9	35,500	62.2	35,300	66.1	35,400	69.7	35,500	72.6	35,600
30	11.8	24,800	46.2	25,100	56.6	24,900	61.3	25,400	65.6	25,900	68.9	26,500
35			37.1	18,400	50.6	17,900	56.3	18,400	61.4	19,100	65.3	19,700
40			25.2	13,600	44.0	13,200	51.1	13,800	57.0	14,400	61.6	15,100
45					36.5	9,900	45.3	10,500	52.6	11,100	57.7	11,800
50					27.0	7,300	38.9	7,900	47.7	8,600	53.7	9,300
55					11.3	5,300	31.3	5,900	42.2	6,700	49.4	7,400
60							21.5	4,300	36.3	5,100	44.9	5,800
65									29.4	3,800	39.9	4,500
70									20.1	2,700	34.3	3,400
75											27.8	2,500
80											19.2	1,800
D	0°											

LIFTING CAPACITIES AT ZERO DEGREE BOOM ANGLE ON OUTRIGGERS												
MID EXTENDED 18' 1/2"(5.5m)SPRED 360° ROTATION												
C	36.4'		50'		61.8'		70'		80'		90'	
	B	(11.1m)	B	(15.24m)	B	(18.83m)	B	(21.34m)	B	(24.38m)	B	(27.43m)
0°	30.3	24,300	43.9	10,700	55.7	5,100	63.9	3,300	73.9	1,900	83.9	1,400

ON OUTRIGGERS MID EXTENDED 18' 1/2"(5.5m) SPREAD											
360° ROTATION											
B	100'		110'		120'		130'		137.8'		
	C	(30.48m)	C	(33.53m)	C	(36.58m)	C	(39.62m)	C	(42m)	
15	80.0	36,500									
20	77.5	35,900	78.7	29,000	79.8	24,900					
25	74.6	32,300	76.1	29,000	77.5	24,900	78.7	20,800	79.4	17,600	
30	71.4	25,900	73.6	25,400	75.1	22,600	76.5	19,800	77.6	17,600	
35	68.3	20,200	70.6	20,700	72.6	19,400	74.4	18,100	75.6	17,100	
40	64.9	15,500	67.6	16,000	69.9	15,700	72.1	15,400	73.3	15,200	
45	61.5	12,200	64.7	12,700	67.2	13,000	69.5	13,200	71.2	13,400	
50	58.0	9,700	61.7	10,200	64.4	10,500	67.0	10,700	68.7	10,900	
55	54.4	7,800	58.6	8,200	61.6	8,500	64.3	8,700	66.2	8,900	
60	50.7	6,200	55.3	6,600	58.7	6,900	61.7	7,100	63.7	7,300	
65	46.7	4,900	51.9	5,300	55.8	5,600	59.0	5,800	61.2	6,000	
70	42.4	3,800	48.4	4,200	52.7	4,500	56.3	4,700	58.7	4,900	
75	37.7	2,900	44.6	3,300	49.3	3,600	53.3	3,800	56.1	4,000	
80	32.5	2,100	40.5	2,500	46.0	2,800	50.4	3,000	53.3	3,200	
85	26.2	1,500	36.1	1,900	42.2	2,100	47.1	2,300	50.4	2,500	
90			31.1	1,300	38.2	1,500	43.8	1,700	47.4	1,900	
95									44.2	1,400	
D	18°		25°		34°		40°		43°		

- A :Boom length in feet
- B :Load radius in feet
- C :Loaded boom angle (deg.)
- D :Minimum boom angle (deg.) for indicated length (no load)

# TR-600XXL-4 RATED LIFTING CAPACITIES (IN POUNDS)

ON OUTRIGGERS MID EXTENDED 18' 1/2"(5.5m) SPREAD 360° ROTATION													
C	137.8' (42.0m) Boom + 32.5' (9.9m) Jib						C	137.8' (42.0m) Boom + 58.1' (17.7m) Jib					
	3.5° Tilt		25° Tilt		45° Tilt			3.5° Tilt		25° Tilt		45° Tilt	
	R	W	R	W	R	W		R	W	R	W	R	W
80°	30.9	8,800	43.2	7,800	50.9	6,500	80°	39.4	5,900	59.2	4,500	72.8	3,100
77.5°	39.0	8,800	50.7	7,200	57.7	6,000	77.5°	49.0	5,800	67.3	4,000	80.0	3,000
75°	47.0	8,800	57.8	6,600	64.3	5,500	75°	58.7	5,800	75.0	3,600	87.4	2,800
72.5°	54.3	7,800	64.9	5,900	70.5	5,000	72.5°	66.7	5,000	82.6	3,200	94.8	2,600
70°	61.4	6,900	71.2	5,300	76.7	4,600	70°	74.3	4,300	90.6	2,900	102.0	2,400
67.5°	67.7	5,600	77.7	4,500	82.5	4,100	67.5°	81.7	3,600	98.0	2,700	109.0	2,300
65°	74.0	4,500	83.5	3,800	88.0	3,500	65°	89.0	3,000	106.0	2,400	116.0	2,100
62.5°	80.3	3,500	89.7	3,000	93.5	2,700	62.5°	95.8	2,300	111.0	1,700	121.0	1,500
60°	86.3	2,600	95.1	2,200	98.9	2,000	60°	103.0	1,500	117.0	1,100	126.0	1,000
57.5°	92.3	1,900	101.0	1,600	104.0	1,500							
55°	98.0	1,300	106.0	1,100	109.0	1,000							

ON OUTRIGGERS MID EXTENDED 18' 1/2"(5.5m) SPREAD 360° ROTATION													
C	110' (33.53m) Boom + 32.5' (9.9m) Jib						C	110' (33.53m) Boom + 58.1' (17.7m) Jib					
	3.5° Tilt		25° Tilt		45° Tilt			3.5° Tilt		25° Tilt		45° Tilt	
	R	W	R	W	R	W		R	W	R	W	R	W
80°	24.4	12,300	36.2	11,000	43.5	8,000	80°	32.2	7,900	53.0	5,700	65.8	3,800
77.5°	30.9	12,300	42.3	10,100	49.0	7,600	77.5°	39.9	7,900	60.2	5,200	71.8	3,600
75°	37.4	12,300	48.3	9,300	54.7	7,200	75°	48.3	7,900	67.1	4,800	77.3	3,500
72.5°	43.8	11,800	54.2	8,600	59.7	6,800	72.5°	55.8	7,500	73.5	4,500	83.3	3,400
70°	49.8	11,200	59.7	8,000	64.9	6,500	70°	62.8	7,100	80.1	4,200	89.2	3,200
67.5°	55.3	9,300	65.1	7,200	70.0	6,200	67.5°	69.2	6,200	86.1	4,000	94.2	3,100
65°	60.5	7,600	70.3	6,400	74.8	6,000	65°	75.5	5,300	92.3	3,700	99.5	3,000
62.5°	65.8	6,200	75.2	5,300	79.4	4,900	62.5°	81.4	4,200	97.6	3,200	104.0	2,700
60°	70.9	5,000	79.9	4,300	83.8	4,000	60°	87.3	3,300	103.0	2,600	109.0	2,400
57.5°	75.9	4,000	84.5	3,500	88.3	3,400	57.5°	93.0	2,600	108.0	2,100	113.0	2,000
55°	80.8	3,200	89.2	2,800	92.3	2,800	55°	98.5	2,000	113.0	1,600	118.0	1,500
52.5°	85.5	2,600	93.4	2,300	96.5	2,300	52.5°	104.0	1,500	117.0	1,200	122.0	1,100
50°	90.2	2,000	97.7	1,800	100.0	1,800	50°	109.0	1,000				
47.5°	94.6	1,500	102.0	1,400	104.0	1,400							
45°	98.8	1,100	106.0	1,000	107.0	1,000							

**C** :Loaded boom angle (deg.)  
**R** :Load radius in feet  
**W** :Rated lifting capacity in pounds

# TR-600XXL-4 RATED LIFTING CAPACITIES (IN POUNDS)

ON OUTRIGGERS MIN EXTENDED 9' 2-1/4"(2.8m) SPREAD												
360° ROTATION												
B	A	36.4'		50'		61.8'		70'		80'		90'
	C	(11.1m)	C	(15.24m)	C	(18.83m)	C	(21.34m)	C	(24.38m)	C	(27.43m)
10	66.9	66,000	73.6	66,000	77.2	62,000	78.9	44,100				
12	63.4	48,900	71.1	48,900	75.3	48,300	77.2	44,100	79.2	44,100		
15	57.8	33,600	67.4	33,500	72.4	33,100	74.7	34,200	76.9	35,600	78.8	37,000
20	47.4	20,400	60.9	20,200	67.3	20,000	70.3	20,600	73.1	21,400	75.4	22,100
25	34.6	13,300	53.9	13,100	62.0	12,700	65.8	13,300	69.1	13,900	71.9	14,600
30	11.7	8,700	46.2	8,400	56.4	8,000	61.0	8,600	65.2	9,300	68.3	10,000
35			37.0	5,200	50.4	4,800	56.0	5,400	61.0	6,200	64.8	6,900
40			25.2	2,900	43.9	2,600	50.8	3,200	56.6	4,000	61.2	4,700
45											57.3	3,000
50											53.3	1,800
D			0°		36°		45°		52°		49°	

LIFTING CAPACITIES AT ZERO DEGREE BOOM ANGLE ON OUTRIGGERS				
FULLY RETRACTED 9' 2-1/4"(2.8m)SPRED 360° ROTATION				
C	A	36.4'		50'
	B	(11.1m)	B	(15.24m)
0°	30.3	8,500	43.9	1,300

ON OUTRIGGERS MIN EXTENDED 9' 2-1/4"(2.8m) SPREAD										
360° ROTATION										
B	A	100'		110'		120'		130'		137.8'
	C	(30.48m)	C	(33.53m)	C	(36.58m)	C	(39.62m)	C	(42m)
15	79.9	30,000								
20	77.0	22,600	78.3	23,100	79.5	20,500				
25	73.9	15,100	75.6	15,500	77.0	15,600	78.3	15,700	79.2	15,800
30	70.8	10,500	72.8	10,900	74.4	11,200	76.0	11,400	77.1	11,600
35	67.5	7,300	70.0	7,700	71.8	8,000	73.6	8,300	74.7	8,500
40	64.4	5,100	67.1	5,500	69.3	5,800	71.2	6,000	72.4	6,200
45	61.1	3,400	64.2	3,800	66.5	4,100	68.2	4,300	70.0	4,500
50	57.6	2,200	61.2	2,500	63.8	2,800	66.1	3,000	67.7	3,200
55			58.1	1,500	61.0	1,700	63.7	1,900	65.3	2,100
D		54°		57°		60°		63°		64°

- A : Boom length in feet
- B : Load radius in feet
- C : Loaded boom angle (deg.)
- D : Minimum boom angle (deg.) for indicated length (no load)

NOTE: The lifting capacity data stored in the LOAD MOMENT INDICATOR (AML-L) is based on the standard number of parts of line listed in the chart.

Standard number of parts of line for outrigger operation should be according to the following table.

Boom length in feet (meters)	36.4' (11.1m)	36.4' to 50' (11.1m to 15.24m)	50' to 61.8' (15.24m to 18.83m)	61.8' to 137.8' (18.83m to 42.0m)	Single top Jib
Number of parts of line	10	8	6	4	1

# WARNING AND OPERATING INSTRUCTIONS FOR LIFTING CAPACITIES

## GENERAL

1. RATED LIFTING CAPACITIES apply only to the machine as originally manufactured and normally equipped by TADANO LTD. Modifications to the machine or use of optional equipment other than that specified can result in a reduction of capacity.
2. Hydraulic cranes can be hazardous if improperly operated or maintained. Operation and maintenance of this crane must be in compliance with information in the **Operation and Maintenance Manual** supplied with the crane. If this manual is missing, order a replacement through the distributor.
3. The operator and other personnel associated with this machine shall fully acquaint themselves with the latest American National Standards Institute (ANSI) safety standards for cranes.

## SET UP

1. Rated lifting capacities on the load chart are the maximum allowable crane capacities. They are based on the machine standing level on a firm supporting surface under ideal job conditions. Depending on the nature of the supporting surface, it may be necessary to have structural supports under the outrigger floats or tires to spread the loads to a larger surface.
2. For outrigger operation, outriggers shall be properly extended with tires free of supporting surface before operating crane.

## OPERATION

1. Rated lifting capacities have been tested to and meet minimum requirements of SAE J1063-Cantilevered Boom Crane Structures Method of Test.
2. Rated lifting capacities do not exceed 85 % of the tipping load on outriggers fully extended as determined by SAE J765-Crane Stability Test Code.  
Rated lifting capacities for partially extended outriggers are determined by this formula, Rated Lifting Capacities = (Tipping Load - 0.1 x Tip Reaction)/1.25.
3. Rated lifting capacities above bold lines in the chart are based on crane strength and those below, on its stability. They are based on actual load radius increased by boom deflection.
4. The weight of handling device such as hook blocks, slings, etc., must be considered as part of the load and must be deducted from the lifting capacities.
5. Rated lifting capacities are based on freely suspended loads and make no allowance for such factors as the effect of wind, sudden stopping of loads, supporting surface conditions, inflation of tires, operating speeds, side loads, etc. Side pull on the boom or jib is extremely dangerous.
6. Rated lifting capacities do not account for the effects of wind on a lifted load or boom. Rated lifting capacities and boom length shall be appropriately reduced, when wind velocity exceeds 20 mph(9 m/sec.).
7. Rated lifting capacities at load radius shall not be exceeded. Do not tip the crane to determine allowable loads.
8. Do not operate at boom lengths, radii, or boom angle, where no capacities are shown. Crane may overturn without any load on the hook.
9. When boom length is between values listed, refer to the rated lifting capacities of the next longer and next shorter booms for the same radius. The lesser of the two rated lifting capacities shall be used.

10. When making lifts at a load radius not shown, use the next longer radius to determine allowable capacity.
11. Load per line should not exceed 12,300 lbs. (5,600kg) for main winch and auxiliary winch.
12. Check the actual number of parts of line with LOAD MOMENT INDICATOR (AML-L) before operation. Maximum lifting capacity is restricted by the number of parts of line of LOAD MOMENT INDICATOR (AML-L). Limited capacity is as determined from the formula, Single line pull for main winch (12,300 lbs.) x number of parts of line
13. The boom angle before loading should be greater to account for deflection. For rated lifting capacities, the loaded boom angle and the load radius is for reference only.
14. The 36.4' (11.1m) boom length capacities are based on boom fully retracted. If not fully retracted [less than 50'(15.24m) boom length], use the rated lifting capacities for the 50' (15.24m) boom length.
15. Extension or retraction of the boom with loads may be attempted within the limits of the RATED LIFTING CAPACITIES. The ability to telescope loads is limited by hydraulic pressure, boom angle, boom length, crane maintenance, etc.
16. For lifting capacity of single top, reduce the rated lifting capacities of relevant boom according to a weight reductions for auxiliary load handling equipment. Capacities of single top shall not exceed 12,300 lbs. (5,600kg) including main hook.
17. When base jib or top jib or both jib removing, jib state switch select removed.
18. When erecting and stowing jib, be sure to retain it by hand or by other means to prevent its free movement.
19. Use "ANTI-TWO BLOCK" disable switch when erecting and stowing jib and when stowing hook block. While the switch is pushed, the hoist does not stop, even when overwind condition occurs.
20. For boom length with 32.5' (9.9m) jib, rated lifting capacities are determined by loaded boom angle only in the column headed "137.8' (42.0m) boom + 32.5' (9.9m) jib".  
For boom length with 58.1' (17.7 m) jib, rated lifting capacities are determined by loaded boom angle only in the column headed "137.8' (42.0m) boom + 58.1' (17.7m) jib".  
For angles not shown, use the next lower loaded boom angle to determine allowable capacity.
21. When lifting a load by using jib (aux. winch) and boom (main winch) simultaneously, do the following:
  - Enter the operation status as jib operation, not as boom operation.
  - Before starting operation, make sure that mass of load is within rated lifting capacity for jib.

## DEFINITIONS

1. Load Radius: Horizontal distance from a projection of the axis of rotation to supporting surface before loading to the center of the vertical hoist line or tackle with load applied.
2. Loaded Boom Angle: The angle between the boom base section and the horizontal, after lifting the rated lifting capacity at the load radius.
3. Working Area: Area measured in a circular arc about the centerline of rotation.
4. Freely Suspended Load: Load hanging free with no direct external force applied except by the hoist line.
5. Side Load: Horizontal side force applied to the lifted load either on the ground or in the air.

# TR-600XXL-4 RATED LIFTING CAPACITIES (IN POUNDS)

ON RUBBER STATIONARY												
A	Over Front						360° Rotation					
	36.4'		61.8'		90'		36.4'		61.8'		90'	
	C	(11.1m)	C	(18.83m)	C	(27.43m)	C	(11.1m)	C	(18.83m)	C	(27.43m)
10	66.9	65,000					66.9	39,000				
12	63.4	58,600					63.4	31,000				
15	57.8	48,500	72.3	34,100			57.8	23,000	72.3	21,500		
20	47.4	33,000	67.3	30,000			47.4	14,000	67.2	13,100		
25	34.6	22,500	62.1	21,000	72.0	20,700	34.6	8,900	61.8	8,000	71.8	10,000
30	11.6	16,000	56.3	14,500	68.6	17,000	11.6	5,700	56.2	4,800	68.2	6,800
35			50.5	10,700	65.1	12,500			50.3	2,700	64.8	4,500
40			43.9	8,000	61.3	9,800					61.1	2,900
45			36.4	5,800	57.5	7,500					57.3	1,600
50			27.1	4,000	53.5	6,000						
55			11.3	2,500	49.2	4,600						
60					44.8	3,600						
65					39.7	2,600						
70					34.2	1,900						
D	0°			32°			0°		36°		56°	

LIFTING CAPACITIES AT ZERO DEGREE BOOM ANGLE ON RUBBER STATIONARY												
A	Over Front						360° Rotation					
	36.4'		61.8'				36.4'					
	B	(11.1m)	B	(18.83m)			B	(11.1m)				
0°	30.3	15,600	55.7	2,400			30.3	5,500				

ON RUBBER CREEP												
A	Over Front											
	36.4'		61.8'		90'							
	C	(11.1m)	C	(18.83m)	C	(27.43m)						
10	66.9	50,000										
12	63.4	43,000										
15	57.8	36,000	72.3	33,000								
20	47.4	27,000	67.3	26,000								
25	34.6	21,000	62.1	20,000	72.0	20,000						
30	11.6	16,000	56.3	14,500	68.6	16,000						
35			50.5	10,700	65.1	12,500						
40			43.9	8,000	61.3	9,800						
45			36.4	5,800	57.5	7,500						
50			27.1	4,000	53.5	6,000						
55			11.3	2,500	49.2	4,600						
60					44.8	3,600						
65					39.7	2,600						
70					34.2	1,900						
D	0°			32°								

- A** : Boom length in feet
- B** : Load radius in feet
- C** : Loaded boom angle (deg.)
- D** : Minimum boom angle (deg.)  
for indicated length (no load)

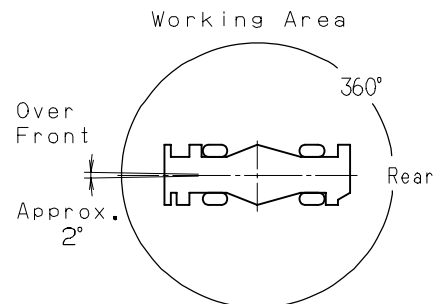

LIFTING CAPACITIES AT ZERO DEGREE BOOM ANGLE ON RUBBER CREEP												
A	Over Front											
	36.4'		61.8'									
	B	(11.1m)	B	(18.83m)								
0°	30.3	15,600	55.7	2,400								

NOTE: The lifting capacity data stored in the LOAD MOMENT INDICATOR (AML-L) is based on the standard number of parts of line listed in the chart. Standard number of parts of line for on rubber operation should be according to the following table.

Boom length in feet (meters)	36.4' (11.1m)	36.4' to 90' (11.1m to 27.43m)	Single top
Number of parts of line	6	4	1

# FOR ON RUBBER LIFTING CAPACITIES

- Rated lifting capacities on rubber are in pounds and do not exceed 75 % of tipping loads as determined by SAE J765-Crane Stability Test Code.
- Rated lifting capacities shown in the chart are based on condition that crane is set on firm level surfaces with axle oscillation lockout applied. Those above bold lines are based on tire capacity and those below, on crane stability. They are based on actual load radius increased by tire deformation and boom deflection.
- If the axle oscillation lockout cylinders contain air, the axle will not be locked completely and rated lifting capacities may not be obtainable. Bleed the cylinders according to the operation safety and maintenance manual.
- Rated lifting capacities are based on proper tire inflation, capacity and condition. Damaged tires are hazardous to safe operation of crane.
- Tires shall be inflated to correct air pressure.
- Over front operation shall be performed within two degrees in front of chassis.
- On rubber lifting with "jib" is not permitted. Maximum permissible boom length is 90 ft. (27.43m).
- When making lift on rubber stationary, set parking brake
- For creep operation, boom must be centered over front of machine, swing lock engaged, and load restrained from swinging. Travel slowly and keep the lifted load as close to the ground as possible, and especially avoid any abrupt steering, accelerating or braking.
- Do not operate the crane while carrying the load.
- Creep is motion for crane not to travel more than 200 ft. (60 m) in any 30 minute period and to travel at the speed of less than 1mph (1.6km/h).
- For creep operation, set Drive select switch to "4-WHEEL (Lo)" and set gear shift lever to "1".

Tires	Air Pressure
29.5-25 22PR	60 psi (4.2 kgf/cm <sup>2</sup> )

## WARNING AND OPERATING INSTRUCTIONS FOR USING THE LOAD MOMENT INDICATOR (AML-L)

- When operating crane on outriggers:
  - Set P.T.O. switch to "ON".
  - Press the outrigger mode select key to register for the outrigger operation. Press the register key, then the outrigger mode indicative symbol changes from flashing to a solid light.
  - Press the lift mode select key to select the lift status that corresponds to the actual boom configuration. Each time the lift mode select key is pressed, the status changes. Press the register key to register the lift status, then the lift indicative symbol changes from flashing to a solid light.
  - When mounting and stowing jib, select the jib set status. (jib state indicative symbol flicker).
- When operating crane on rubber:
  - Set P.T.O. switch to "ON".
  - Press the outrigger mode select key. The on-tire mode indicative symbol comes on. Each time the outrigger mode select key is pressed the mode changes. Select the creep operation, the on-tire mode indicative symbol flicker.
  - Press the lift mode select key to register the boom or single top lift. However, pay attention to the following.
    - For stationary operation.
      - The front capacities are attainable only when the over front position symbol comes on. When the boom is more than 2 degrees from centered over front of chassis, 360° capacities are in effect.
      - When a load is lifted in the front position and then swung to the side area, make sure the value of the LOAD MOMENT INDICATOR(AML-L) is below the 360° lifting capacity.
    - For creep operation.
      - The creep capacities are attainable only when boom is in the straight forward position of chassis and the over front position symbol is on. If boom is not in the straight forward position of chassis , never lift load.
- This crane is equipped with an automatic swing sensor/stopping device.(For the details,see Operation & Maintenance Manual.) However, the automatic swing stop does not activate in the following cases.
  - When the "SWING STOP OVERRIDE" switch is turned ON.
  - During ON-RUBBER operation.
  - When the "P.T.O." switch is set to "OVERRIDE"and the "AML OVERRIDE" key switch outside the cab is ON.
- During crane operation, make sure that the displays on front panel are in accordance with actual operating conditions.
- The displayed values of LOAD MOMENT INDICATOR (AML-L) are based on freely suspended loads and make no allowance for such factors as the effect of wind, sudden stopping of loads, supporting surface conditions, inflation of tire, operating speed, side loads, etc. For safe operation, it is recommended when extending and lowering boom or swinging, lifting loads shall be appropriately reduced.
- LOAD MOMENT INDICATOR (AML-L) is intended as an aid to the operator. Under no condition should it be relied upon to replace use of capacity charts and operating instruction. Sole reliance upon LOAD MOMENT INDICATOR (AML-L) aids in place of good operating practice can cause an accident. The operator must exercise caution to assure safety.

## TR-600XXL- 4 Axle weight distribution chart

	Pounds			Kilograms		
	GVW	Front	Rear	GVW	Front	Rear
Base machine	95,877	52,946	42,931	43,489	24,016	19,473
Remove:						
1. 60 ton (54.4 metric ton) hook block	-996	-1,798	802	-452	-815	363
2. 6.2 ton (5.6 metric ton) hook ball	-289	-403	115	-131	-183	52
3. Hot water cab heater and air conditioner	-214	-68	-146	-97	-31	-66
4. Top jib (25.6')	-677	-809	132	-307	-367	60
5. Base jib (32.5')	-1,832	-3,391	1,559	-831	-1,538	707
6. Auxiliary lifting sheave	-110	-313	203	-50	-142	92

