

()
Raupenkran · Crawler Crane
Grue sur chenilles

LR 1750

Zusatzblatt zum technischen Datenblatt
Supplement to technical data sheet
Supplément au descriptif

()

Yuekchun Const. Co. Ltd

TEL +82 22691 6000

FAX +82 22691 6001

Web : y6000.co.kr

E - mail1 : yccglobal@gmail.com

E - mail2 : y6000@paran.com

Pedestal Crane
Pedestal Crane
Grue sur piédestal

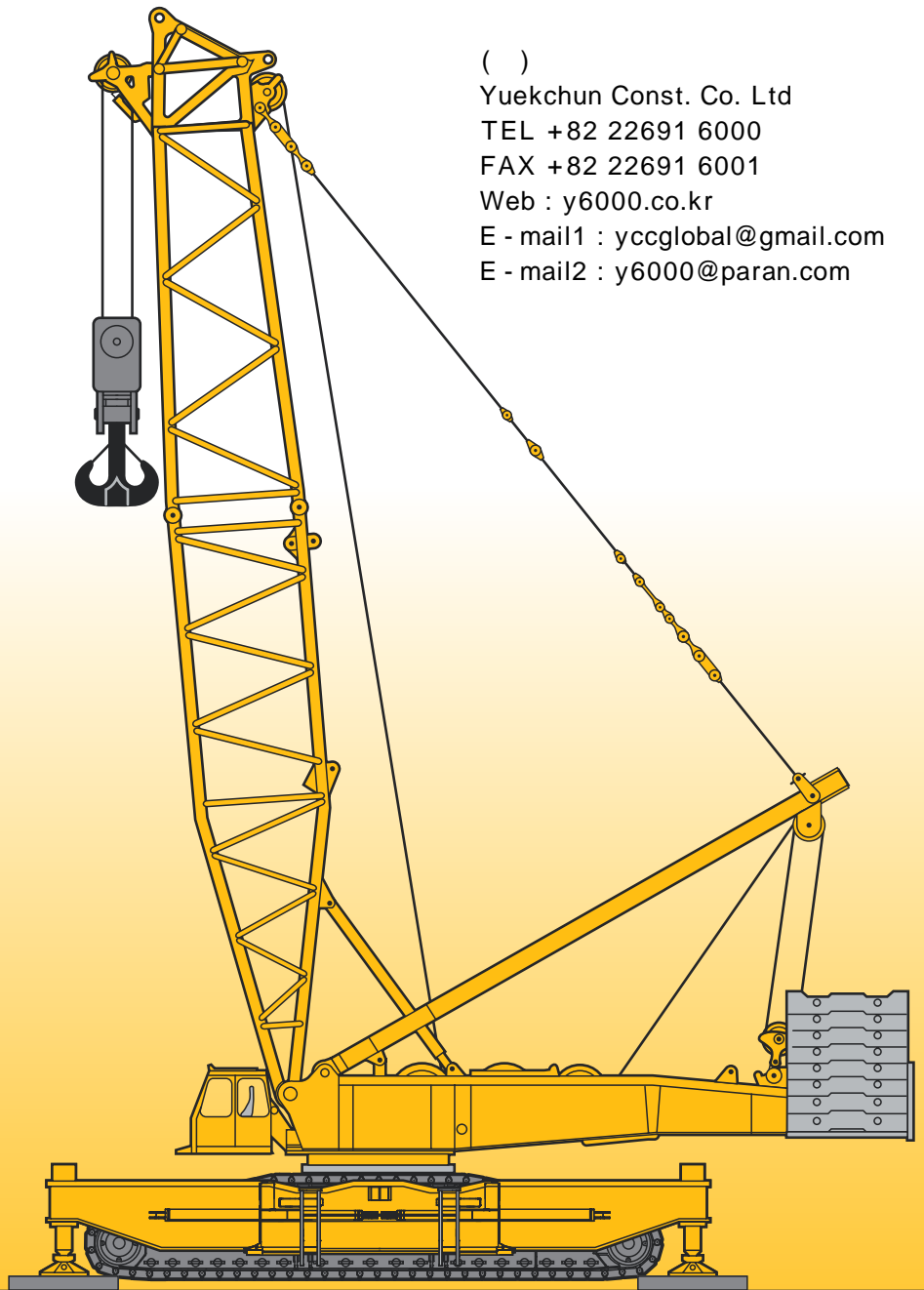

LIEBHERR

Inhaltsverzeichnis

Technische Beschreibung der Sonderausrüstung "Pedestal Crane"	4
Maße	5 – 9
Transportplan	10 – 12
Traglasten und Hubhöhen am SL-Ausleger	13 – 15
Traglasten und Hubhöhen am SLD-Ausleger	16 – 17
Traglasten und Hubhöhen am S-Ausleger	18 – 19
Traglasten und Hubhöhen am SD-Ausleger	20 – 21
Traglasten und Hubhöhen am SW-Ausleger	22 – 26

Table of content

Technical description of the optional equipment "Pedestal Crane"	4
Dimensions	5 – 9
Transportation plan	10 – 12
Lifting capacities and lifting heights on SL boom	13 – 15
Lifting capacities and lifting heights on SLD boom/derrick combination	16 – 17
Lifting capacities and lifting heights on S boom	18 – 19
Lifting capacities and lifting heights on SD boom/derrick combination	20 – 21
Lifting capacities and lifting heights on SW boom/jib combination	22 – 26

Tables des matières

Description technique de l'équipement spécial "Grue sur piédestal"	4
Les dimensions	5 – 9
Plan de transport	10 – 12
Les forces de levage et hauteurs de levage à la flèche principale SL	13 – 15
Les forces de levage et hauteurs de levage en configuration SLD	16 – 17
Les forces de levage et hauteurs de levage à la flèche principale S	18 – 19
Les forces de levage et hauteurs de levage en configuration SD	20 – 21
Les forces de levage et hauteurs de levage en configuration SW	22 – 26

Technische Beschreibung der Sonderausrüstung "Pedestal Crane"

Zur Traglaststeigerung ohne Derricksystem, Reduzierung der Bodendrücke und Nivellierung des Krans

Hydraulische Kranabstützung	Hydraulisch verstellbare Abstützarme, direkt an das Raupenmittelteil oder an die Raupenträger anbaubar. Abstützbasen bei Anbau an die Raupenträger quadratisch: 13,0 m x 13,0 m rechteckig: 16,0 m x 12,0 m Abstützbasen bei Anbau direkt an das Raupenmittelteil quadratisch: 12,6 m x 12,6 m rechteckig: 16,0 m x 10,5 m Traglasttabellen für rechteckige Abstützbasis $\pm 30^\circ$ sowie 360° .	Verstärktes Raupenfahrzeuggestell	Verstärkung des Raupenmittelteils und der Raupenträger.
		Drehbühnenverlängerung	Verlängerung der Drehbühne um 2,5 m. Erhöhung des Drehbühnenballastes um 5 t auf gesamt 250 t. Nur in Verbindung mit der hydraulischen Kranabstützung.
		Bodenplatten	Bodenplatten (6,0 m x 2,4 m x 0,3 m) bleiben beim Verfahren an den Stützen

Technical description of the optional equipment "Pedestal Crane"

For the load capacity increase without derricking system, reduction of the base pressures and levelling of the crane

Hydraulic crane supporting system	Hydraulically adjustable outriggers, to be mounted to the crawler centre section or to the crawler carriers. Supporting bases when mounted to the crawler carriers square: 13,0 m x 13,0 m rectangular: 16,0 m x 12,0 m Supporting bases when mounted to the crawler centre section square: 12,6 m x 12,6 m rectangular: 16,0 m x 10,5 m Load charts for rectangular supporting base $\pm 30^\circ$ as well as 360° .	Reinforced crawler chassis	Reinforcement of the crawler centre section and of the crawler carriers.
		Extension of the superstructure	Extension of the superstructure by 2,5 m. Increase of the superstructure ballast by 5 t to a total of 250 t. Only in conjunction with the hydraulic crane supporting system.
		Base plates	The base plates (6,0 m x 2,4 m x 0,3m) remain fixed to the outriggers during the displacement of the crane.

Description technique de l'équipement spécial "Grue sur piédestal"

Pour l'augmentation de la charge sans système de Derrick, réduction des pressions au sol et nivelage de la grue

Calage hydraulique de la grue	Bras de calage réglables hydrauliquement, pouvant être directement montés sur la partie centrale du châssis ou sur les longerons. Bases de calage pour montage sur les longerons carrée: 13,0 m x 13,0 m rectangulaire: 16,0 m x 12,0 m Bases de calage pour montage sur la partie centrale du châssis carrée: 12,6 m x 12,6 m rectangulaire: 16,0 m x 10,5 m Tableaux de charges pour une base de calage rectangulaire $\pm 30^\circ$ et 360° .	Châssis avec chenilles renforcé	Renforcement de la partie centrale du châssis et des longerons.
		Extension de la tourelle	Extension de la tourelle de 2,5 m. Augmentation de 5 t du contre poids de la tourelle pour un total de 250 t. Uniquement avec calage hydraulique de la grue.
		Tuiles	Les tuiles (6,0 m x 2,4 m x 0,3 m) restent montées sur les stabilisateurs en conduite.

Maße Dimensions Encombrement

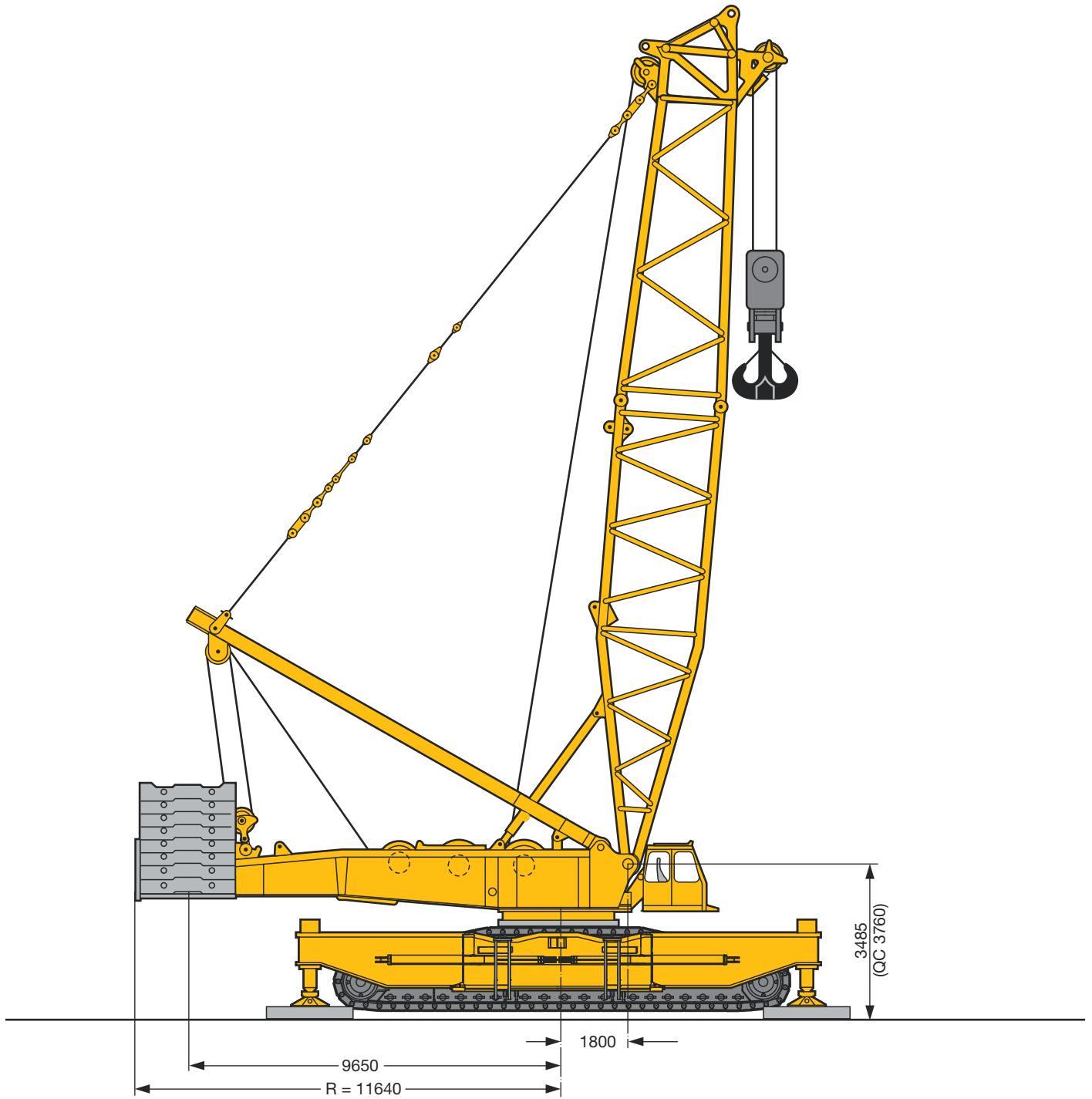

QC = Quick Connection

S1422

Maße Dimensions Encombrement

Betriebsart
Operating mode
Mode d'emploi

C

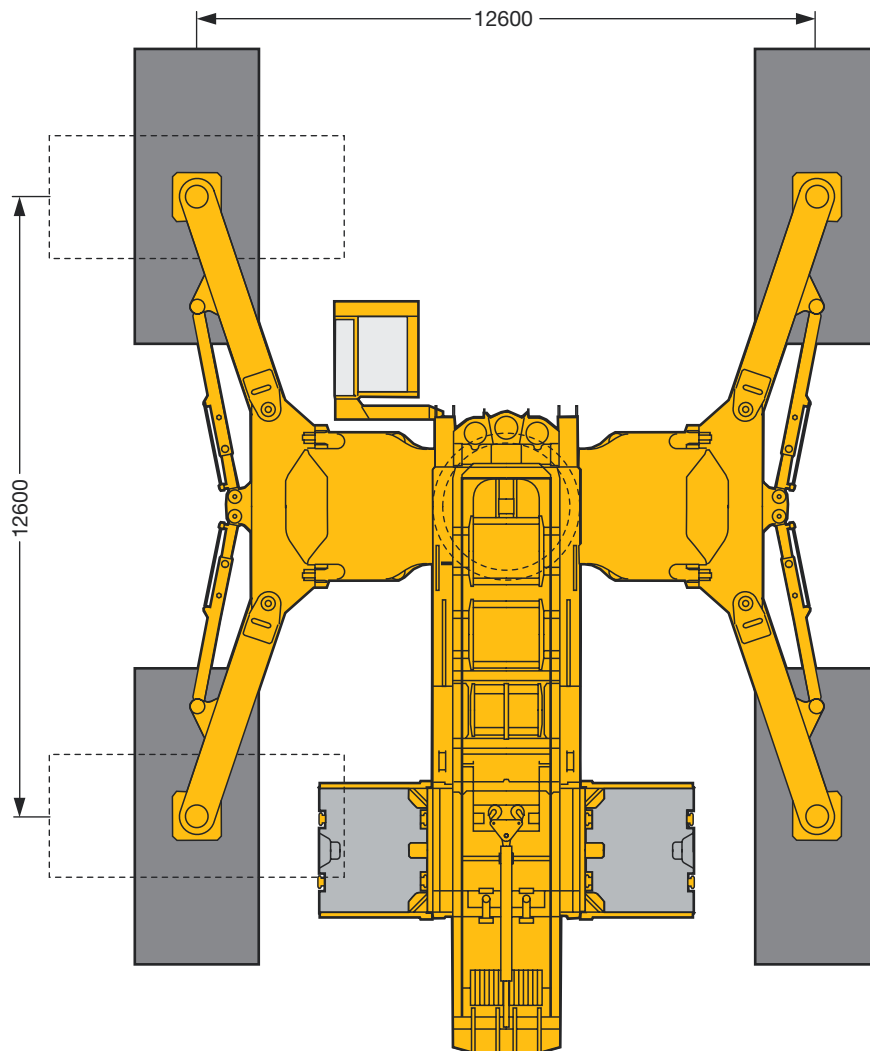
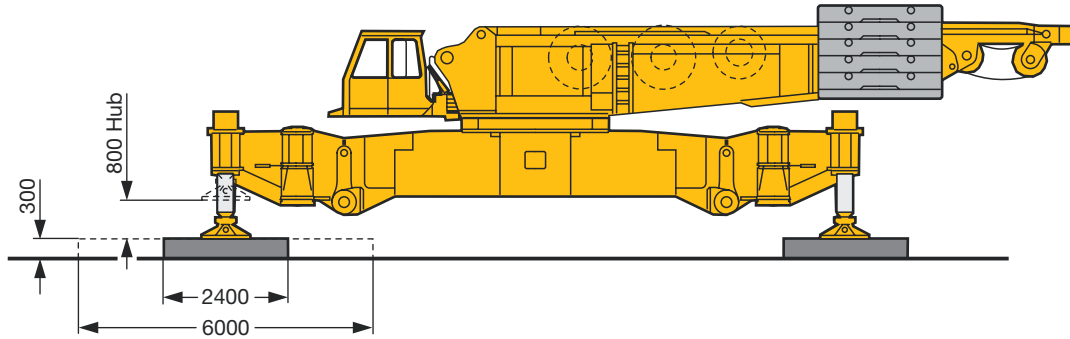

Abstützbasis
supporting base
surface de calage

12,6 m x 12,6 m

S1423

Maße Dimensions Encombrement

Betriebsart
Operating mode
Mode d'emploi

E / F

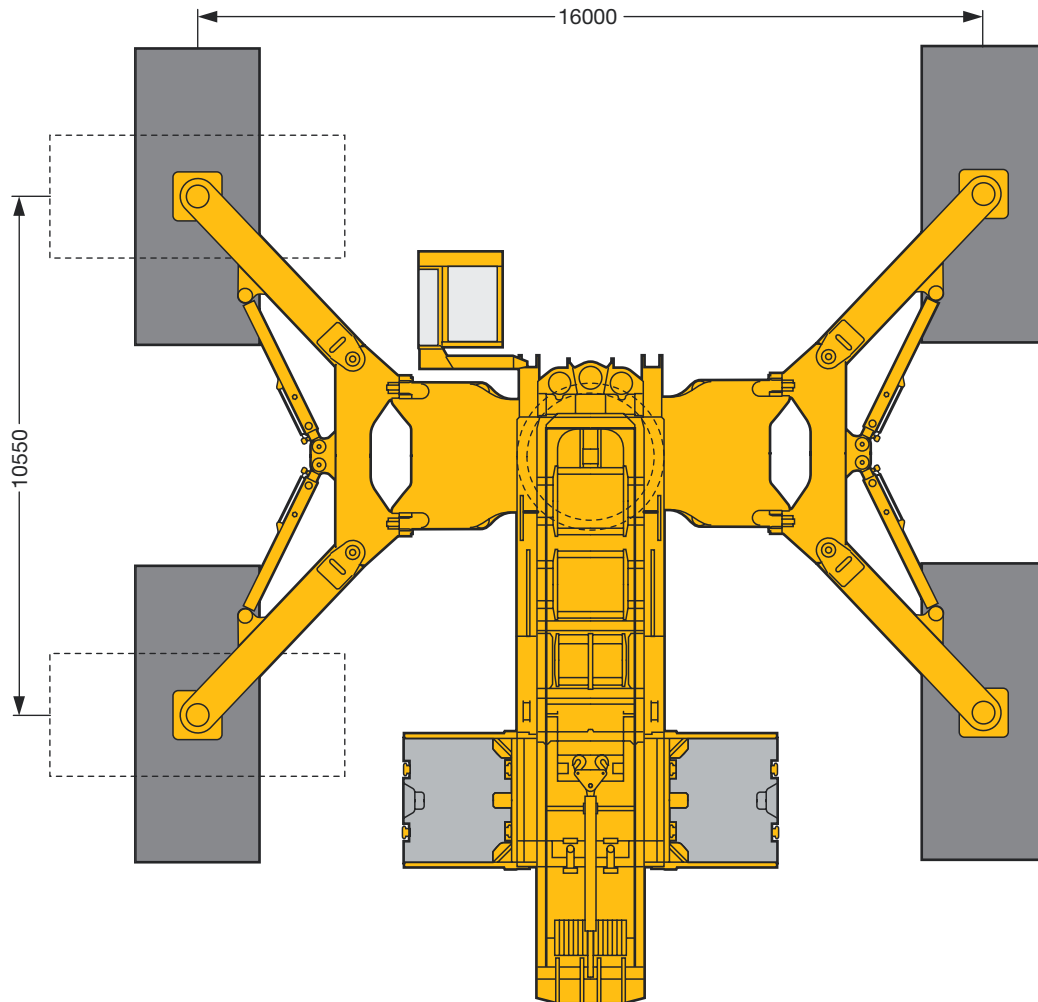
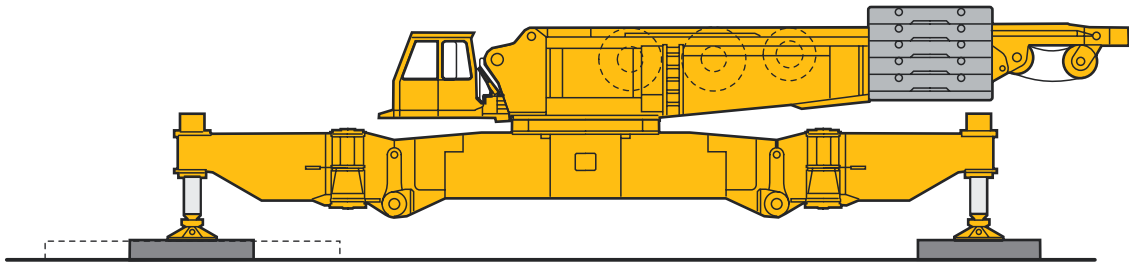

Abstützbasis
supporting base
surface de calage

16 m x 10,5 m

S1424

Maße Dimensions Encombrement

Betriebsart
Operating mode
Mode d'emploi

D

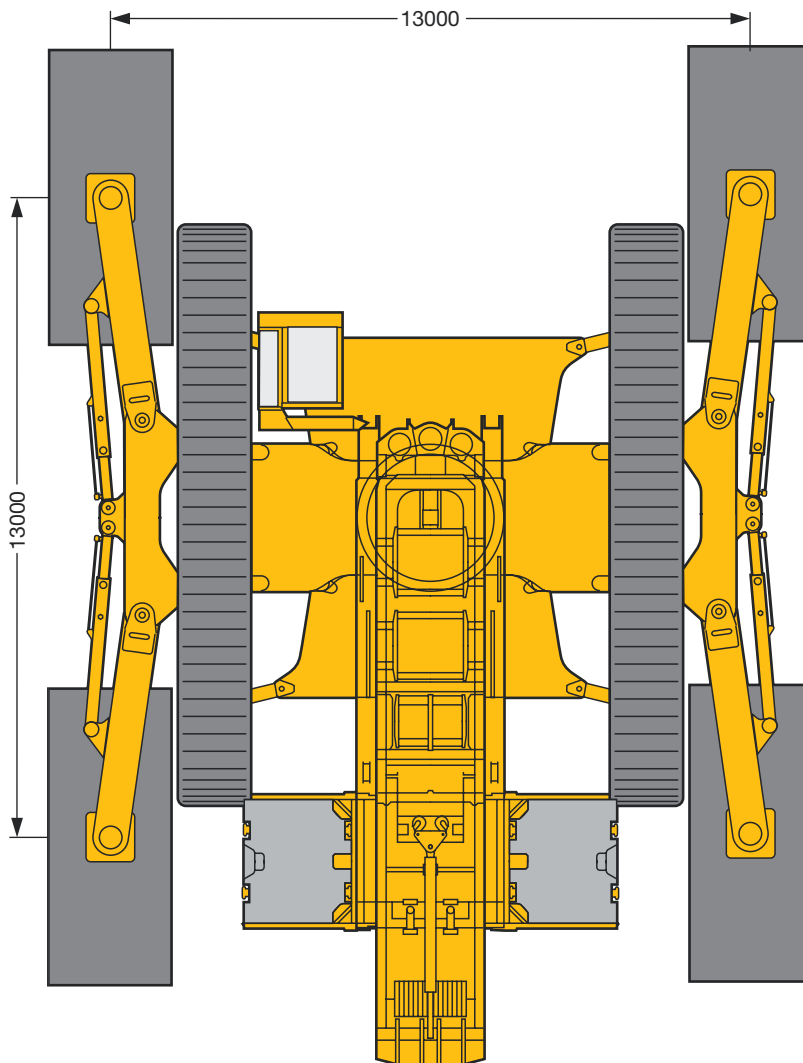
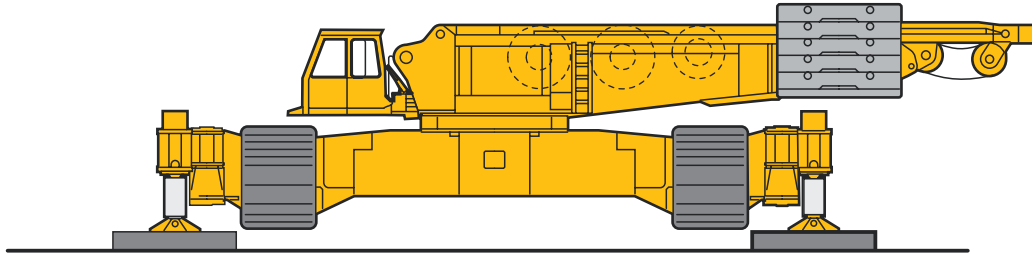

Abstützbasis
supporting base
surface de calage

13 m x 13 m

S1425

Maße Dimensions Encombrement

Betriebsart
Operating mode
Mode d'emploi

G / H

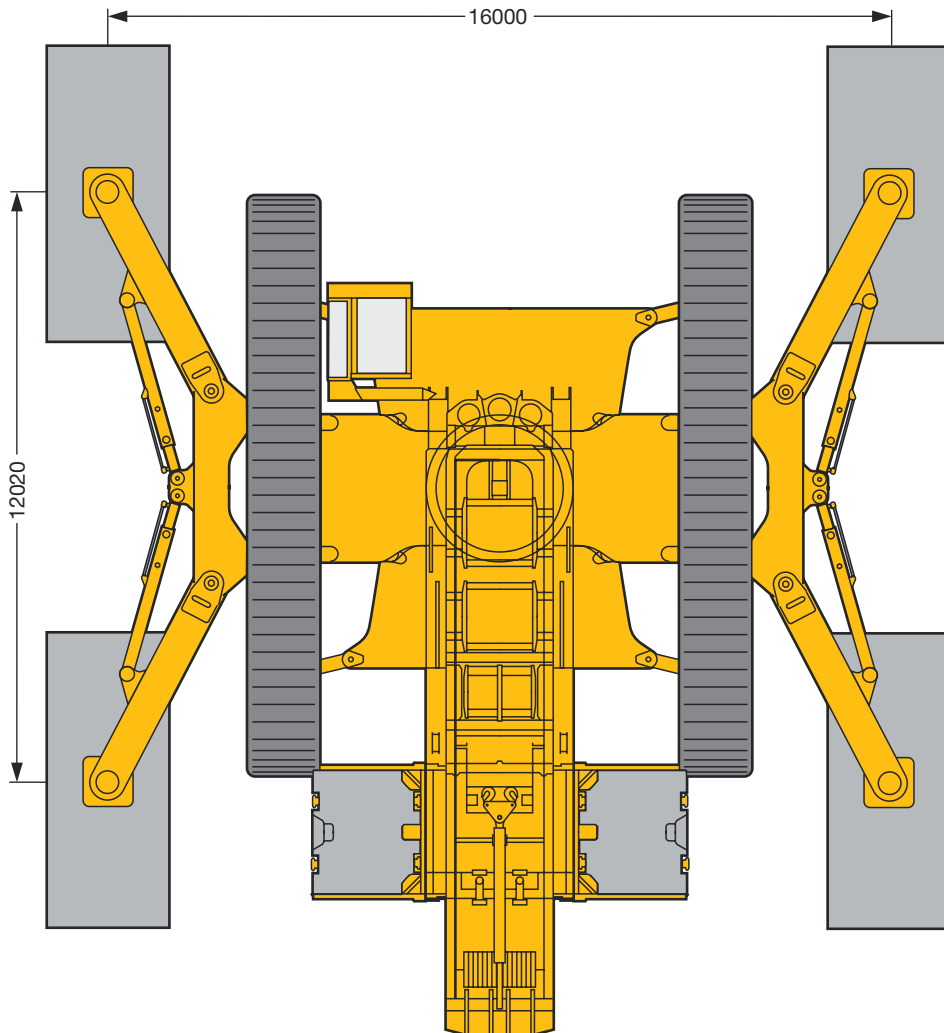
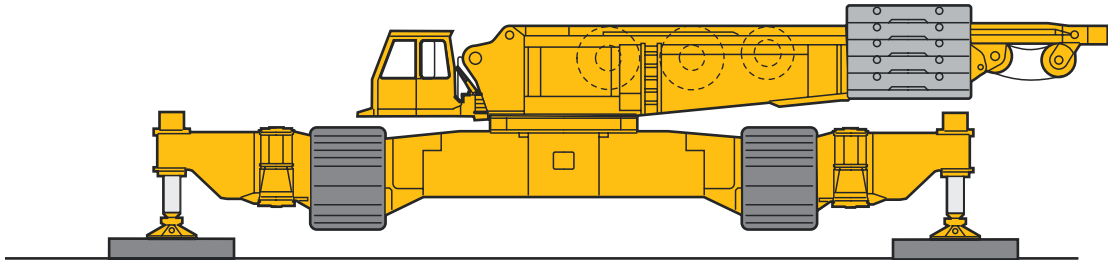

Abstützbasis
supporting base
surface de calage

16 m x 12 m

S1426

Transportplan
Transportation plan
Plan de transport

Drehbühne und Raupenmittelteil mit SA-Bock, Winde 4, Montageabstützung
 Superstructure and crawler center section with SA-frame, with assembly jacks
 Partie tourante et partie centrale du porteur avec chevalet SA, avec vérins de montage

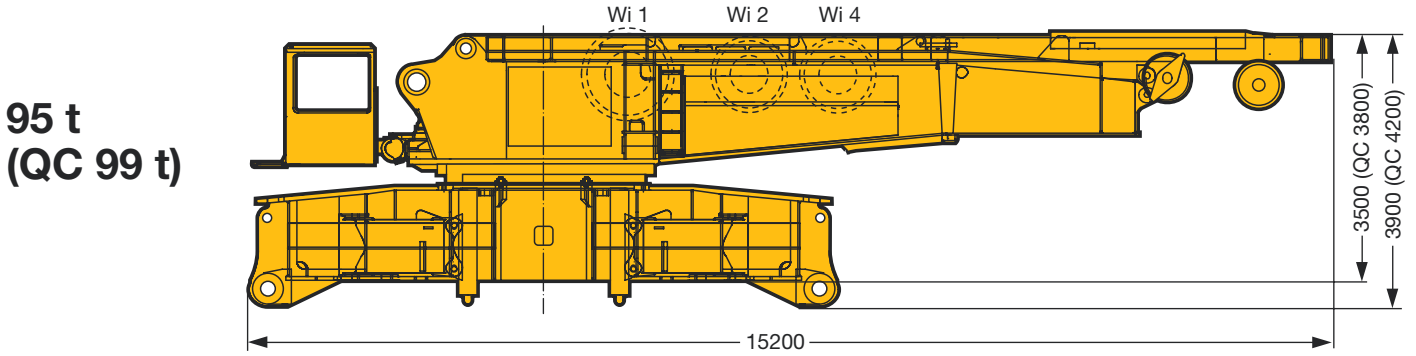

Drehbühne mit SA-Bock, Winde 4, Quick Connection, 2 Drehwerken
 Superstructure with SA-frame, winch 4, quick connection, 2 slewing gears
 Partie tourante avec chevalet SA, treuil 4, quick connection, 2 orientations

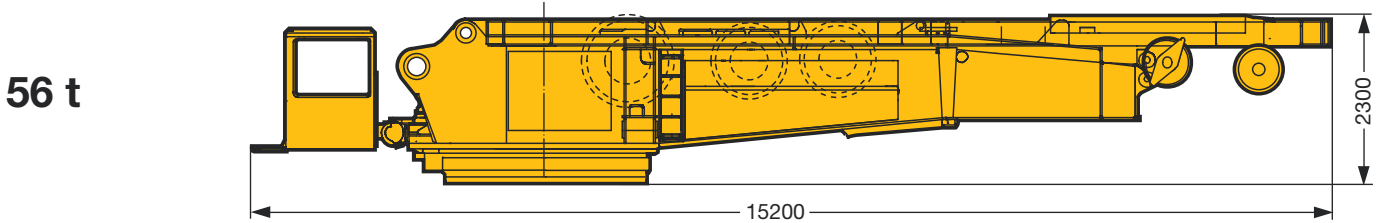

Raupenmittelteil mit hydr. Montageabstützung, Quick Connection
 Crawler center section with assembly jacks, quick connection
 Partie centrale du porteur avec éris de montage, quick connection

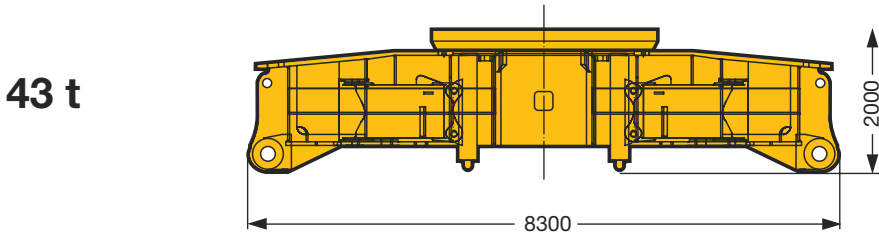

Raupenträger mit 1 (2) Fahrgetriebe
 Crawler carrier with 1 (2) travelling gear
 Porteur à chenilles avec 1 (2) trains de roulement

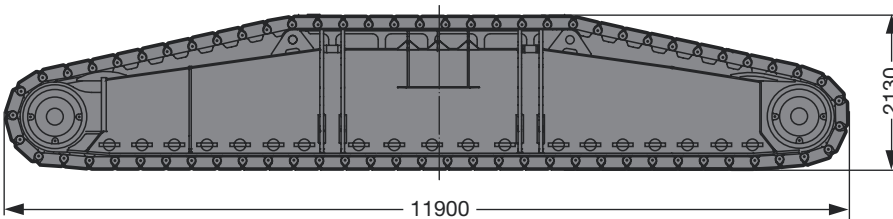

Bodenplatten
 Track pads
 Pains de chenille

1,5 m	2 m
44 t	53 t
(46 t)	(55 t)

QC = Quick Connection
 Wi = Winde/winch/treuil

S1427

Transportplan
Transportation plan
Plan de transport

Drehbühne und Raupenmittelteil, Montageabstützung
 Superstructure and crawler center section, assembly jacks
 Partie tourante et partie centrale du porteur, vérins de montage

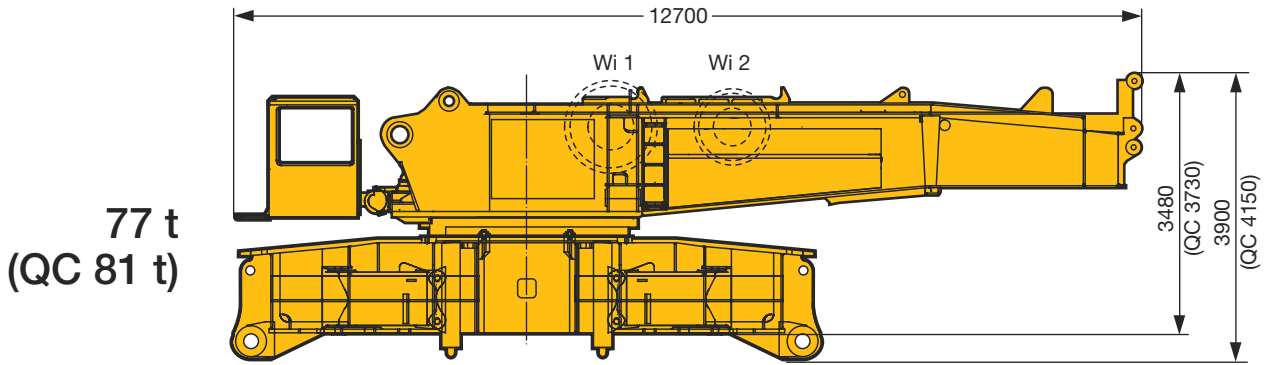

Drehbühne mit Quick Connection
 Superstructure with quick connection
 Partie tourante avec quick connection

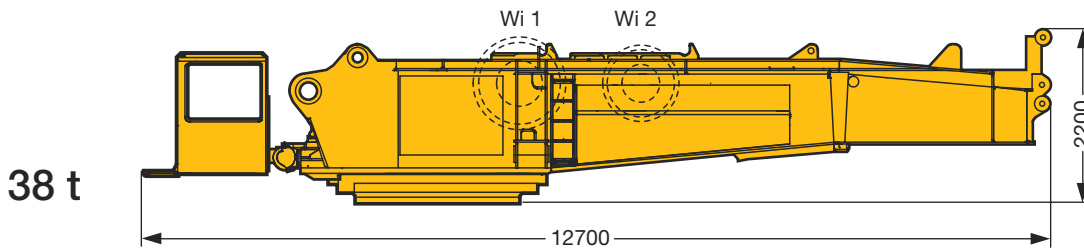

SA-Bock, Winde 4 inkl. Seil und Rollensatz
 SA-frame, winch 4 incl. rope and pulley block
 Chevalet SA, treuil 4 incl. câble et bloc de poulies

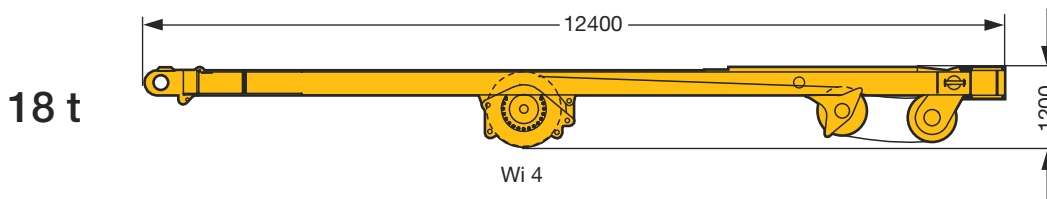

Winde 1 inkl. Seil
 Winch 1 incl. rope
 Treuil 1 incl. câble

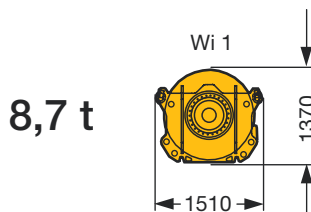

Winde 2 inkl. Seil
 Winch 2 incl. rope
 Treuil 2 incl. câble

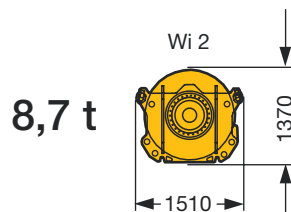

QC = Quick Connection
 Wi = Winde/winch/treuil

S1428

Transportplan Transportation plan Plan de transport

Kranabstützung
Outrigger
Calage

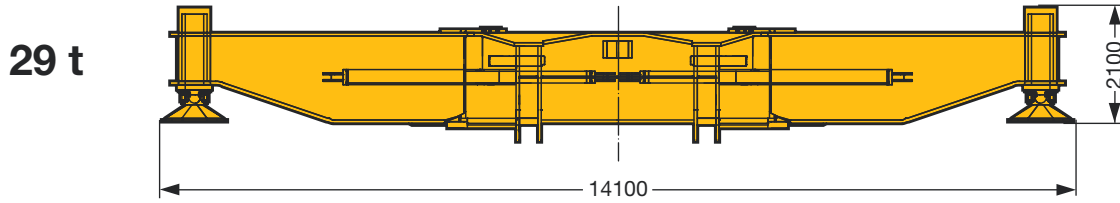

Matratze
Crane mat
Mat

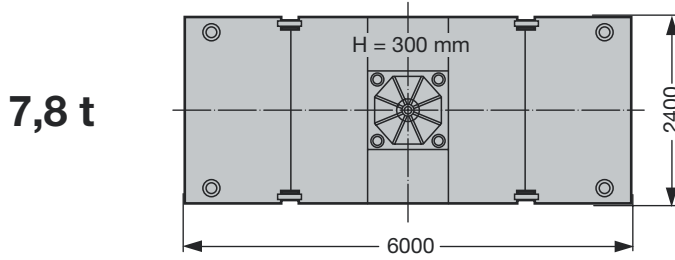

Ballastrahmen
Counterweight base frame
Cadre de lest

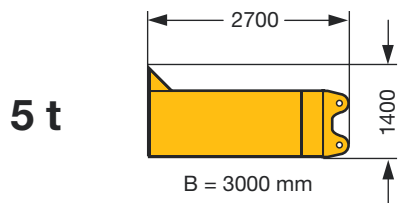

S1429

Traglasten am SL-Ausleger Lifting capacities on SL boom Forces de levage à la flèche principale SL

		28 m	35 m	42 m	49 m	56 m	63 m	70 m	77 m	84 m	91 m	98 m	105 m		
6	C	400												C	6
	D													D	
6,5	C	400												C	6,5
	D													D	
7	C	400	400											C	7
	D													D	
8	C	400	400	400	400									C	8
	D													D	
9	C	400	400	400	400	385	366							C	9
	D													D	
10	C	400	400	400	398	382	364	343	285					C	10
	D													D	
11	C	376	374	373	371	369	361	340	280	270				C	11
	D	400	400	400	395	379								D	
12	C	345	343	342	339	338	335	334	276	267	214	202		C	12
	D	384	382	381	378	376	359	339						D	
14	C	293	291	290	288	286	284	283	267	256	207	198	161	C	14
	D	329	327	326	324	322	319	313						D	
16	C	252	251	250	247	246	244	242	240	243	201	194	157	C	16
	D	284	282	281	279	278	276	274	259	244				D	
18	C	221	220	218	216	215	213	211	237	232	194	187	153	C	18
	D	250	248	247	245	243	241	239	238					D	
20	C	197	195	194	192	190	188	182	211	209	188	179	148	C	20
	D	222	220	219	217	215	213	212						D	
22	C	177	175	174	172	170	191	189	188	186	182	171	143	C	22
	D	200	198	197	195	193					183			D	
24	C	160	158	157	155	174	172	171	170	168	165	158	139	C	24
	D	176	179	178	176						167	164		D	
26	C	146	145	144	161	159	157	155	154	152	150	143	135	C	26
	D	150	164	163							152	150		D	
28	C		133	132	147	146	143	142	141	139	137	131	128	C	28
	D		151	150							138	136	131	D	
30	C		123	138	136	134	132	130	129	127	126	120	118	C	30
	D		133								127	125	125	D	
32	C		113	128	126	124	122	120	119	117	116	111	108	C	32
	D		116								117	115	115	D	
34	C			117	117	115	113	112	110	108	107	102	100	C	34
	D										108	106	106	D	
36	C			105	109	108	105	104	103	101	99	95	93	C	36
	D										100	98	98	D	
38	C			93	101	100	99	97	96	94	92	88	86	C	38
	D					10					93	91	91	D	
40	C			81	92	93	91	90	89	87	86	82	80	C	40
	D					95	92	91			87	85	85	D	
44	C				75	80	79	78	77	75	75	71	70	C	44
	D						81	79	78	77	76	73	72	D	
48	C					67	69	68	67	65	65	62	61	C	48
	D							69	68	66	66	63	62	D	
52	C					54	58	59	59	57	56	54	54	C	52
	D													D	
56	C						48	50	51	49,5	49	46	46,5	C	56
	D													D	
60	C							42	43,5	42,5	42,5	40	39	C	60
	D													D	

TAB 128107 / 128133 / 128102 / 128132 / 128108 / 128103

Traglasten am SL-Ausleger

Lifting capacities on SL boom

Forces de levage à la flèche principale SL

		28 m	35 m	42 m	49 m	56 m	63 m	70 m	77 m	84 m	91 m	98 m	105 m	
64	C D C D							34	36,5	36,5	37	34,5	34	C D C D
68	C D C D								29,9	30,5	31,5	29,9	29,7	C D C D
72	C D C D								22,9	24,6	26,1	25,3	25,6	C D C D
76	C D C D									19,2	21,2	21,1	21,8	C D C D
80	C D C D										16,6	17	18,1	C D C D
84	C D C D											13,1	14,7	C D C D
88	C D C D											9,4	11,4	C D C D
92	C D C D												8,2	C D C D
96	C D C D												5,2	C D C D

TAB 128107 / 128133 / 128102 / 128132

Anmerkungen zu den Traglasttabellen

- Für die Kranberechnungen gelten die DINVorschriften lt. Gesetz gemäß Bundesarbeitsblatt von 2/85: Die Traglasten DIN/ISO entsprechen den geforderten Standsicherheiten nach DIN 15019, Teil 2 und ISO 4305 (Prüflast = 1,25 x Hublast + 0,1 x Auslegereigengewicht auf die Ausleger Spitze reduziert). Für die Stahltragwerke gilt DIN 15018, Teil 3. Die bauliche Ausbildung des Krans entspricht DIN 15018, Teil 2 sowie der F.E.M.
- Die Traglasten sind in Tonnen angegeben.
- Das Gewicht des Lasthakens bzw. der Hakenflasche sowie der Anschlagmittel ist von den Traglasten abzuziehen.
- Die Ausladungen sind von Mitte Drehkranz gemessen.
- Kranbetrieb – wenn nicht speziell dokumentiert – zulässig bis: Staudruck 50 N/m², Windgeschwindigkeit 9 m/s.
Weitere Angaben über Windgeschwindigkeiten sind der Bedienungsanleitung zu entnehmen.
- Die Aufstandsfläche muß eben und tragfähig sein.
- Traglaständerungen vorbehalten.

Remarks referring to load charts

- When calculating crane stresses and loads, German Industrial Standards (DIN) are applicable, in conformance with new German legislation (published 2/85). The lifting capacities (stability margin) DIN/ISO correspond to DIN 15019, part 2, and ISO 4305 (Tested load = 1.25 x lifting capacity + 0.1 x boom dead weight, reduced to the boom point). The crane's structural steel work is in accordance with DIN 15018, part 3. Design and construction of the crane comply with DIN 15018, part 2 and with F.E.M. regulations.
- Lifting capacities are given in metric tons.
- The weight of the load hook and hook blocks as well as of the lifting tackle must be deducted from the lifting capacities.
- The working radii are measured from the slewing centreline.
- Unless particularly specified, crane operation is permissible up to a dynamic pressure of 50 N/m², wind speed of 9 m/s.
For further details in respect to wind speeds refer to the operating instructions.
- The subsoil must be even and of good bearing capacity.
- Subject to modification of lifting capacities.

Remarques relatives aux tableaux des charges

- La grue est calculée selon normes DIN conformément au décret fédéral 2/85. Les charges DIN/ISO respectent les sécurités au basculement requises par les normes DIN 15019, partie 2 et ISO 4305. La structure de la grue est conçue selon la norme DIN 15018, partie 3. La conception générale est réalisée selon la norme DIN 15018, partie 2, ainsi que selon les recommandations de la F.E.M.
- Les charges sont indiquées en tonnes.
- Les poids du crochet ou du moufle ainsi que des élingues sont à déduire des charges indiquées.
- Les portées sont prises à partir de l'axe de rotation de la partie tournante.
- Sinon spécifié autrement, le service de grue est admissible jusqu'à une pression dynamique de 50 N/m², vitesse de vent de 9 m/s.
D'autres indications concernant les vitesses de vent sont stipulées dans les instructions de service.
- Le sol doit être plat et résistant.
- Charges données sous réserve de modification.



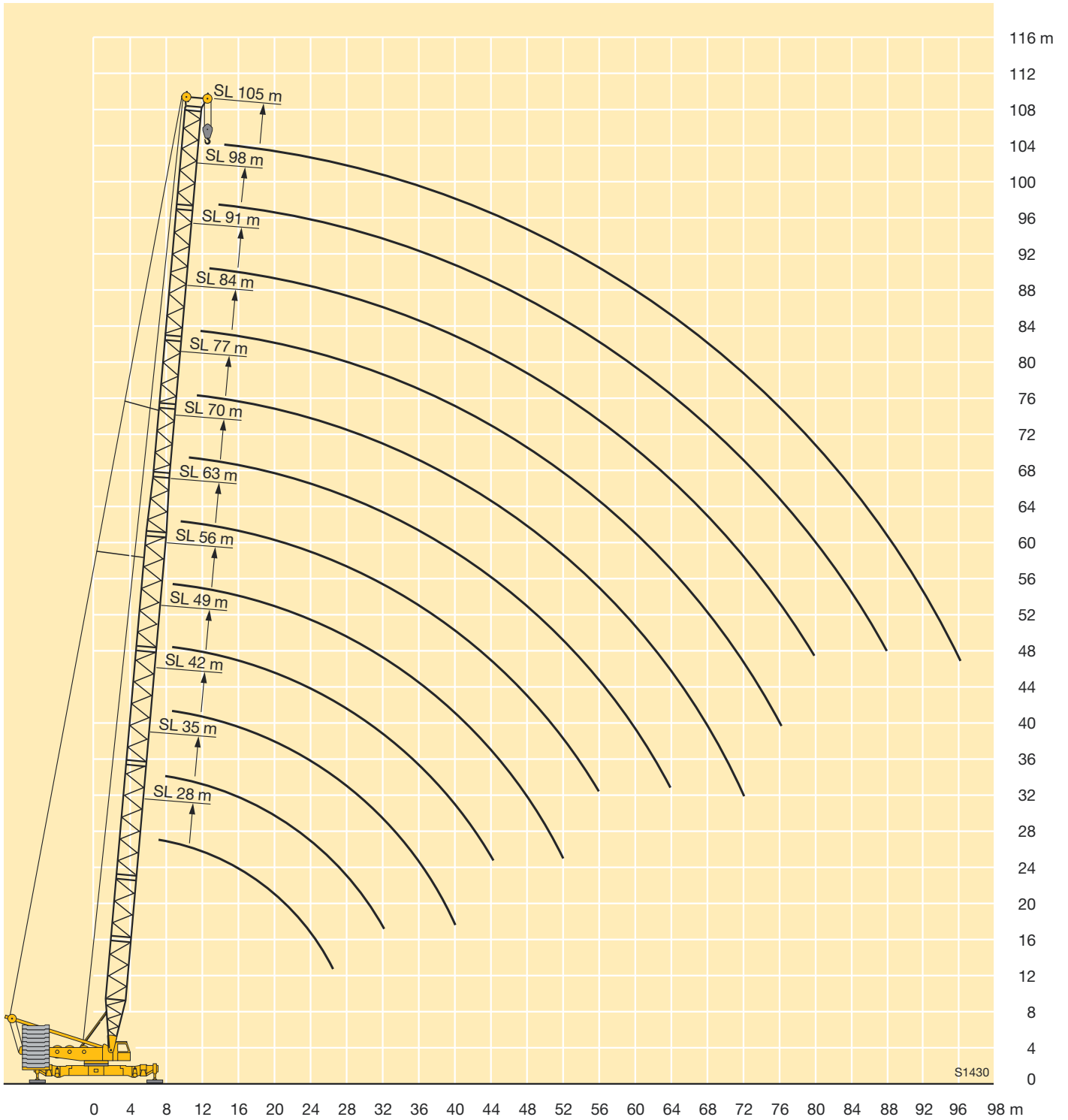





Hubhöhen am SL-Ausleger Lifting heights on SL boom Hauteur de levage à la flèche principale SL



Traglasten am SLD-Auslegersystem

Lifting capacities on SLD boom/derrick combination

Forces de levage en configuration SLD

		 35 m - 133 m	 31,5 m		 12,6 m x 12,6 m	 13 m x 13 m												
		35 m	42 m	49 m	56 m	63 m	70 m	77 m	84 m ²⁾	91 m ²⁾	98 m ²⁾	105 m ²⁾	112 m ²⁾	119 m ²⁾	126 m ²⁾	133 m ²⁾		
7	400																7	
8	400	400	400														8	
9	400	400	400	400													9	
10	400	400	397	382	393	371											10	
11	371	360	357	348	336	346	328	301									11	
12	338	318	321	316	307	296	304	294	253	225							12	
14	279	262	256	260	256	251	246	247	238	222	182	165	134				14	
16	227	221	220	214	211	211	211	206	204	201	180	163	132	120	104		16	
18	195	192	189	187	183	178	179	171	174	175	166	162	131	119	103		18	
20	174	170	165	163	159	156	154	152	151	153	148	142	130	118	102		20	
22	155	151	147	143	141	137	137	134	134	132	131	126	123	117	101		22	
24	137	133	131	128	125	123	121	118	119	114	116	112	110	106	101		24	
26	123	121	120	116	114	110	109	105	106	103	102	99	98	95	93		26	
28	115	110	109	107	105	100	98	95	95	92	91	87	87	85	83		28	
30	107	100	100	99	97	93	89	86	86	82	83	79	77	75	74		30	
32	99	94	91	91	90	86	83	77	78	76	75	71	70	67	65		32	
34		89	83	83	83	79	77	72	72	70	67	64	63	61	58		34	
36		83	78	76	76	73	71	67	67	65	61	57	57	55	53		36	
38		78	73	69	70	68	66	62	61	60	56	52	52	49,5	48		38	
40		73	69	64	64	62	61	58	57	55	51	47,5	46	44,5	43		40	
44			62	58	53	52	52	49,5	47,5	45,5	43	39	38	35,5	34		44	
48				52	47,5	43	44	41,5	38,5	37	37	33,5	30	27,7	25,2		48	
52				46	42,5	38,5	36	34,5	32,5	28,9	30,5	28,1	24,6	20,6	19,5		52	
56					38	34,5	32	27,3	27,3	24	25,1	23,4	20,4	17,4	14,7		56	
60						30,5	28,2	23,4	22,3	19,4	19,8	19	16,5	14,7	10,1		60	
64							26,8	24,9	20,6	19	15,1	14,8	12,8	12,1	6,4		64	
68								21,8	17,9	16,6	12,3	11,5	10,9	9,4	9,8	5,4	68	
72								18,8	15,4	14,4	10,6	9,9	7,1	6,2	7,5	4,4	72	
76									13	12,3	9	8,4	4,3	4	5,4	3,5	76	
80										10,2	7,5	7	3,6	3,4			80	
84											6,1	5,7					84	
88												4,7	4,4				88	
92													3,2				92	

²⁾ nur aufrechtbar mit Derrickballast / raisable only with derrick ballast / seulesment relevable avec contrepoids derrick

Hubhöhen am SLD-Auslegersystem
Lifting heights on SLD boom/derrick combination
Hauteur de levage en configuration SLD

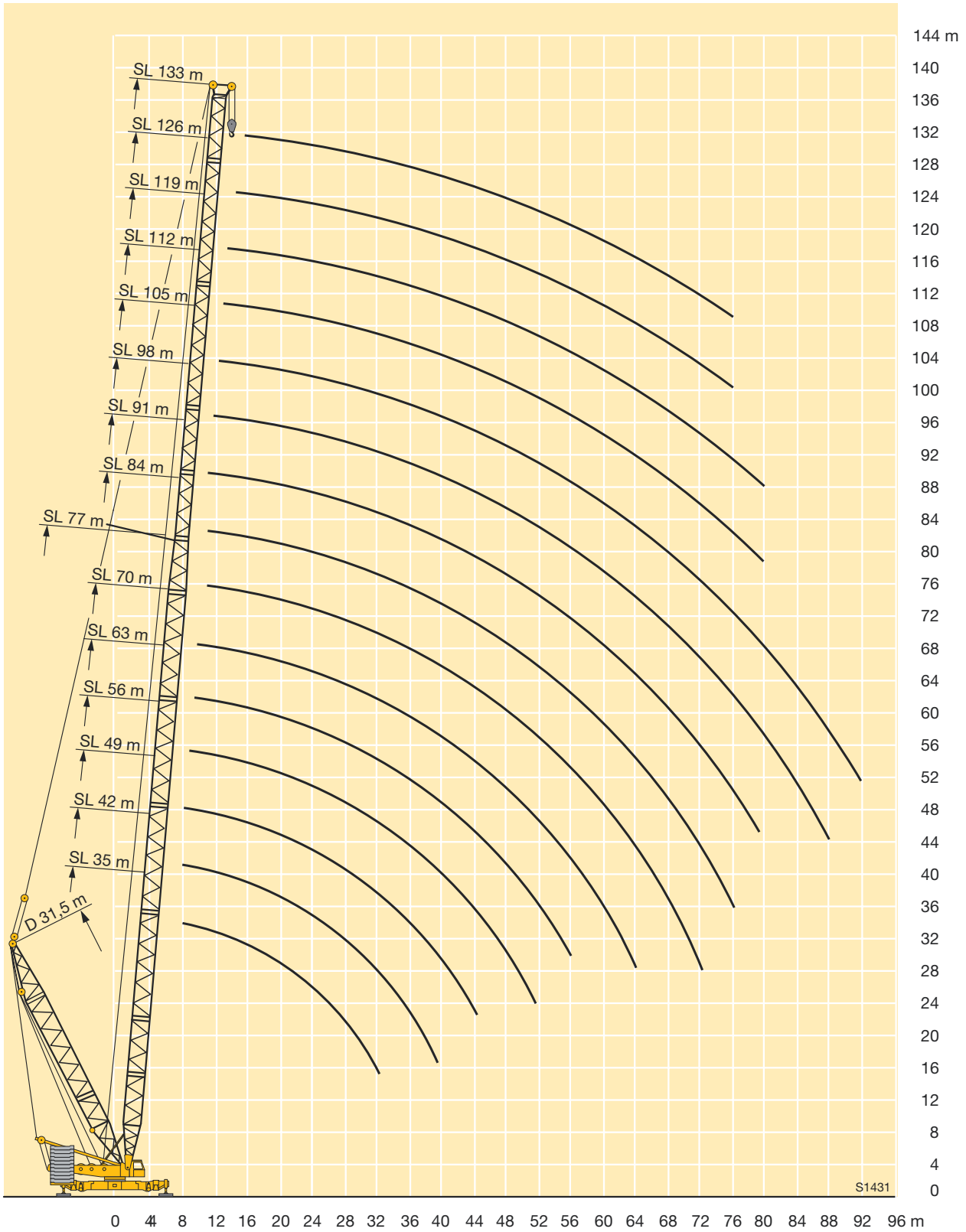

Traglasten am S-Ausleger

Lifting capacities on S boom

Forces de levage à la flèche principale S

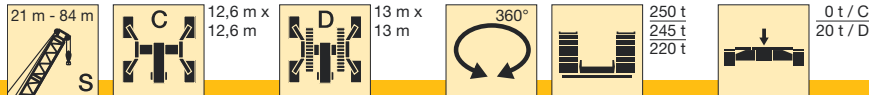

		21 m	28 m	35 m	42 m	49 m	56 m	63 m	70 m	77 m	84 m		
6	C	524										C	6
	D	600										D	
6,5	C	514	507									C	6,5
	D	600	600									D	
7	C	505	498	494								C	7
	D	580	577	575								D	
8	C	481	483	480	472	470						C	8
	D	510	508	505	503	500						D	
9	C	452	453	450	448	445	443					C	9
	D	467	478	477	470	470	465					D	
10	C	410	408	405	403	400	398	396	383			C	10
	D	448	454	451	449	446	444	442	411			D	
11	C	373	371	368	366	363	361	359	350	336	295	C	11
	D	415	413	410	408	405	403	401	400	347	295	D	
12	C	342	340	337	335	332	330	328	321	309	291	C	12
	D	381	379	376	374	371	369	367	365	343	291	D	
14	C	289	287	285	283	281	278	277	275	265	255	C	14
	D	326	324	321	319	316	314	312	310	305	284	D	
16	C	248	247	245	243	240	238	238	245	255	257	C	16
	D	280	279	277	275	272	270	268	267	266	257	D	
18	C	217	216	214	212	209	232				226	C	18
	D	240	244	242	240	237	235	233	232	231	228	D	
20	C	186	191	189	187						200	C	20
	D	186	217	214	212	210	207	206	204	203	202	D	
22	C		171	169		187	185	183	182	180	178	C	22
	D		194	192	190	187	185	183	182	180	179	D	
24	C		155		173	171	169	166	163	162	159	C	24
	D		171		173	171	169	166	163	162	161	D	
26	C		141		158	156	153	151	148	146	144	C	26
	D		144		158	156	153	151	148	146	145	D	
28	C			144	143	140	138	136	134	133	131	C	28
	D			144	143	140	138	136	134	133	131	D	
30	C			126	131	128	126	124	123	121	119	C	30
	D			126	131	128	126	124	123	121	120	D	
32	C			110	121	118	116	114	113	111	109	C	32
	D			110	121	118	116	114	113	111	110	D	
34	C				109	110	107	106	104	102	100	C	34
	D				109	110	107	106	104	102	101	D	
36	C				97	101	100	98	96	95	92	C	36
	D				97	101	100	98	96	95	93	D	
38	C				86	92	93	91	89	88	85	C	38
	D				86	92	93	91	89	88	86	D	
40	C				74	83	85	84	83	81	78	C	40
	D				74	83	85	84	83	81	80	D	
44	C					66	71	71	70	68	67	C	44
	D					66	71	71	70	68	67	D	
48	C						58	60	59	58	56	C	48
	D						58	60	59	58	56	D	
52	C						45,5	49	49,5	49	47	C	52
	D						45,5	49	49,5	49	47	D	
56	C							39,5	41	41	40	C	56
	D							39,5	41	41	40	D	
60	C								32,5	33,5	33,5	C	60
	D								32,5	33,5	33,5	D	
64	C								25	26,5	27,1	C	64
	D								25	26,5	27,1	D	
68	C									20	21,3	C	68
	D									20	21,3	D	
72	C									13,5	15,8	C	72
	D									13,5	15,8	D	
76	C										10,6	C	76
	D										10,6	D	

TAB 128140 / 128141 / 128145 / 128146 / 128364 / 128367



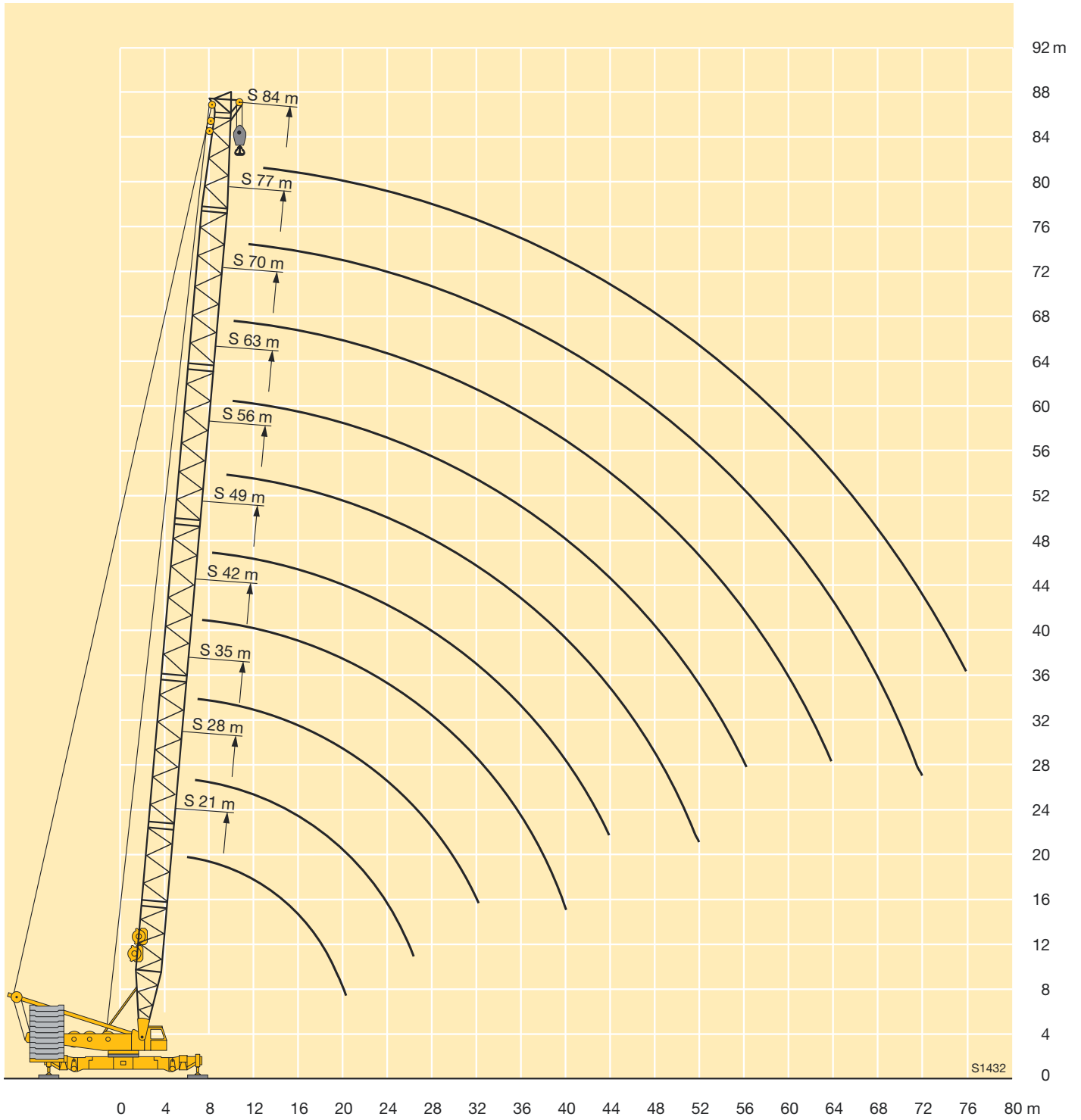





Hubhöhen am S-Ausleger Lifting heights on S boom Hauteur de levage à la flèche principale S



Traglasten am SD-Auslegersystem

Lifting capacities on SD boom/derrick combination

Forces de levage en configuration SD

																				
		35 m	42 m	49 m	56 m	63 m	70 m	77 m	84 m	91 m	98 m	105 m	112 m	119 m	126 m	133 m	140 m			
7	C	517																	D	7
	D	581																	D	
8	C	497	494	490															D	8
	D	511	509	505															D	
9	C	455	453	450	448														D	9
	D	500	493	491	485														D	
10	C	410	408	405	403	401	389												D	10
	D	444	441	439	438	435	436												D	
11	C	373	370	367	366	363	355	348	334										D	11
	D	394	388	386	384	380	382	383	346										D	
12	C	341	339	336	334	332	326	320	307	295									D	12
	D	351	348	343	342	338	338	338	339	298	258								D	
14	C	286	283	281	278	276	273	273	264	268	257	221	192	167					D	14
	D								272										D	
16	C	241	238	235	233	229	227	227	224	224	224	220	192	167	144	124	105		D	16
	D																		D	
18	C	209	206	202	199	195	194	192	190	189	187	187	186	165	143	123	105		D	18
	D													166					D	
20	C	182	180	177	174	169	167	167	164	161	161	161	160	159	143	123	104		D	20
	D																		D	
22	C	160	157	155	152	149	146	144	142	141	139	138	139	138	137	123	104		D	22
	D																		D	
24	C	143	140	137	134	131	128	127	125	123	122	120	119	119	119	117	104		D	24
	D																		D	
26	C	129	127	124	122	116	116	112	110	108	107	106	105	103	103	103	99		D	26
	D																		D	
28	C	119	115	113	111	106	106	100	98	95	95	92	92	91	90	90	87		D	28
	D																		D	
30	C	110	103	102	101	97	98	90	88	85	84	82	81	80	80	78	75		D	30
	D																		D	
32	C	102	96	93	92	89	89	82	79	76	75	73	72	70	70	69	66		D	32
	D																		D	
34	C		89	83	84	81	82	74	71	69	67	65	64	62	61	61	58		D	34
	D																		D	
36	C		84	77	76	74	75	66	63	61	60	57	56	55	54	53	50		D	36
	D																		D	
38	C		78	72	68	67	68	59	57	54	54	51	50	48,5	47,5	46	43,5		D	38
	D																		D	
40	C		73	68	61	60	62	53	52	48	48	46	44	42,5	41,5	40	37,5		D	40
	D																		D	
44	C			60	54	48	49,5	44,5	43	40	38	36	34,5	32	31	29,2	26,4		D	44
	D																		D	
48	C				48	42,5	38,5	36,5	35	32,5	31	26,8	25,6	23,2	23	21,2	17,6		D	48
	D																		D	
52	C					42,5	37,5	33	29,2	27,7	25,9	25,1	21,2	18,1	16,5	16,3	14,8	10,3	D	52
	D																		D	
56	C						32,5	28,5	24,5	20,8	19,7	19,5	16,5	14,6	13,4	10,1	8,8	8	D	56
	D																		D	
60	C							24,5	21	16,5	13,8	14,2	12,2	11,3	10,5	7,1	5,1	6	D	60
	D																		D	
64	C								20,8	17,7	13,9	9,8	9,3	8,2	8,3	7,9	5,6		D	64
	D																		D	
68	C									14,6	11,4	7,8	5,6	5,4	5,3				D	68
	D																		D	
72	C										11,7	9,1	6						D	72
	D																		D	
76	C											6,9							D	76
	D																		D	

TAB 128296 / 128297 / 128298 / 128299 / 128360 / 128361

Hubhöhen am SD-Auslegersystem
Lifting heights on SD boom/derrick combination
Hauteur de levage en configuration SD

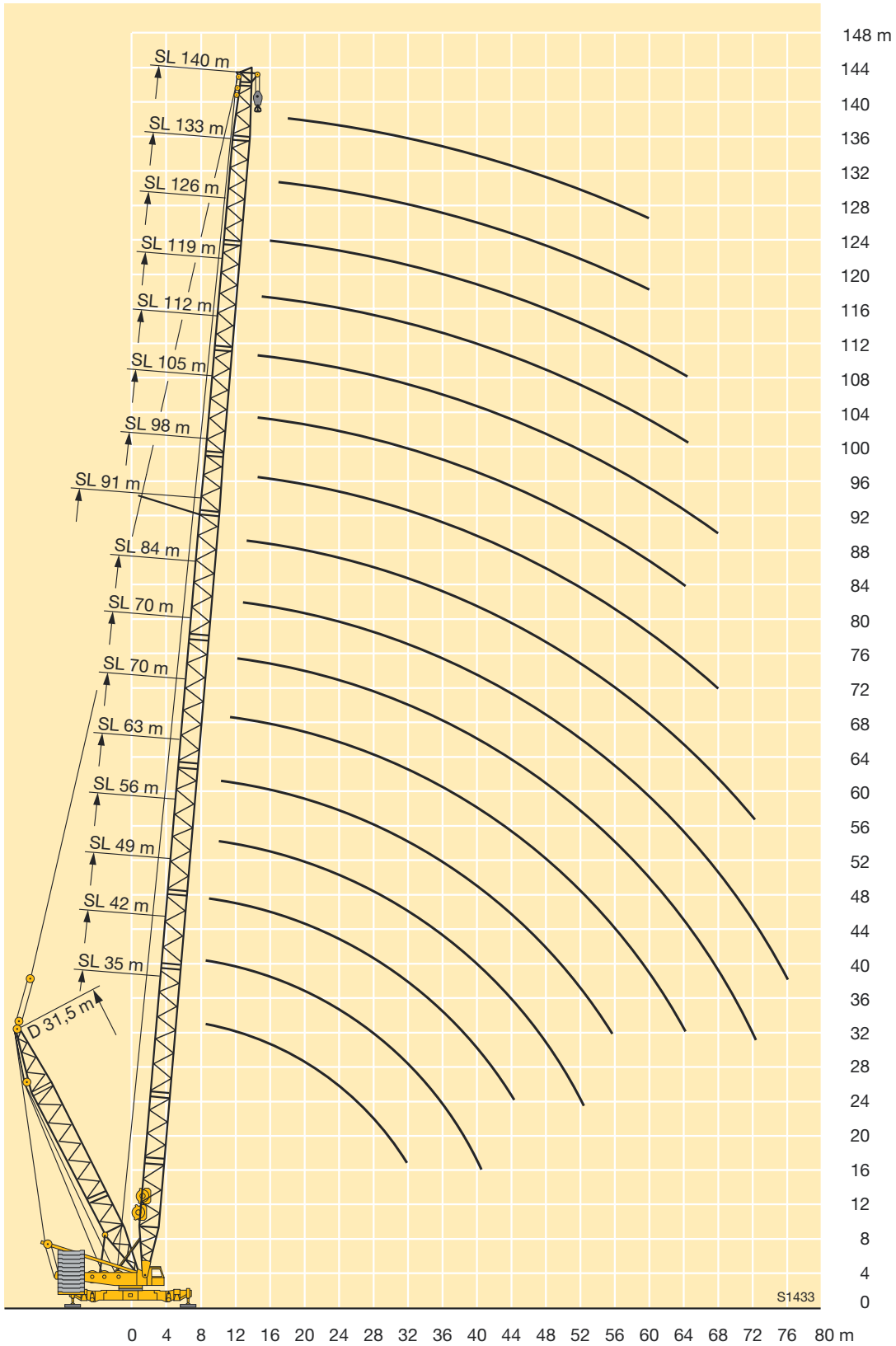

Traglasten am SW-Auslegersystem

Lifting capacities on SW boom/jib combination

Forces de levage en configuration SW

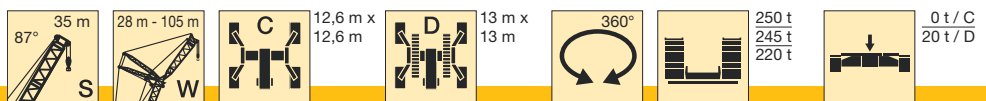

Height (m)	Configuration	35 m											Height (m)	
		28 m	35 m	42 m	49 m	56 m	63 m	70 m	77 m	84 m	91 m	98 m		105 m
14	C	294												14
	D	318												
16	C	254	253	252										16
	D	286	285	264										
18	C	223	222	221										18
	D	251	250	250	216									
20	C	198	197	197										20
	D	224	222	222	195	178								
22	C	178	177	177										22
	D	201	200	199	175	175	149							
24	C	162	161	160										24
	D	183	182	180	177	173	147	124	106					
26	C	148	147	146										26
	D	166	164	165	161	160	145	123	105	89				
28	C	136	135	150										28
	D	151	150		148	146	144	122	104	88	74			
30	C	125												30
	D	139	138	136	137	136	133	122	103	87	74	62		
32	C		127	126										32
	D				125	126	123	120	103	86	73	61	52	
34	C		118	117										34
	D				115	116	114	111	102	85	73	61	52	
36	C		110	109										36
	D				107	107	106	104	101	84	72	60	51	
38	C			101										38
	D				100	99	99	97	95	84	72	59	51	
40	C			95										40
	D				94	92	92	90	90	83	71	59	50	
44	C			84										44
	D				82	82	80	78	79	78	69	58	49,5	
48	C				73									48
	D					72	71	68	68	69	67	57	48,5	
52	C													52
	D					65	63	61	60	60	59	56	47,5	
56	C													56
	D					58	56	54	54	53	52	51	46,5	
60	C													60
	D						51	48,5	48	47,5	45	45	43	
64	C													64
	D						45,5	44	43	42,5	40,5	39,5	38	
68	C													68
	D							39,5	38,5	37,5	36	35,5	33,5	
72	C													72
	D								35	33,5	32	31,5	29,8	
76	C													76
	D								31,5	30,5	28,4	28,1	26,3	
80	C													80
	D									27,4	25,6	24,7	23	
84	C													84
	D										23	21,9	19,9	
88	C													88
	D										20,6	19,5	17,2	
92	C													92
	D											17,3	15,4	
96	C													96
	D											15,2	13,8	
100	C													100
	D												12,2	

TAB 128170 / 128171 / 128175 / 128188 / 128189 / 128193

Traglasten am SW-Auslegersystem

Lifting capacities on SW boom/jib combination

Forces de levage en configuration SW



		42 m													
		28 m	35 m	42 m	49 m	56 m	63 m	70 m	77 m	84 m	91 m	98 m	105 m		
14	C	292												C	14
	D	318												D	
16	C	253	252											C	16
	D	284	277											D	
18	C	222	221	218										C	18
	D	246	248	229	197									D	
20	C	197	196	195	188	163								C	20
	D	219	215	219	191									D	
22	C	177	176	176	187	160	138							C	22
	D	194	194	192										D	
24	C	160	160	173	170	157	135	116						C	24
	D	175	175											D	
26	C	146	146	158	155	152	132	114	98					C	26
	D	160	158											D	
28	C	135	144	145	143	139	130	112	97	82	70			C	28
	D	145												D	
30	C	124	133	132	132	129	126	110	96	81	69	59		C	30
	D	134												D	
32	C		122	121	121	120	117	109	95	80	68	58	49	C	32
	D													D	
34	C		113	113	111	111	109	106	94	80	68	57	48,5	C	34
	D													D	
36	C		106	105	103	103	102	100	92	79	67	57	48	C	36
	D													D	
38	C		98	97	96	95	94	93	90	79	67	56	47,5	C	38
	D													D	
40	C			91	90	88	88	87	85	78	66	56	47	C	40
	D													D	
44	C			81	79	78	76	76	74	74	65	55	46,5	C	44
	D													D	
48	C				70	69	67	66	65	65	62	53	45,5	C	48
	D													D	
52	C					61	60	59	56	57	55	52	44,5	C	52
	D													D	
56	C					55	53	52	51	49,5	48	47,5	44	C	56
	D													D	
60	C						48	46,5	45	44	42	42	40	C	60
	D													D	
64	C						43	42	40	39,5	37,5	36,5	35	C	64
	D													D	
68	C							37,5	36	35	33,5	32,5	30,5	C	68
	D													D	
72	C								32,5	31	29,5	29	26,9	C	72
	D													D	
76	C								29,1	28	25,9	25,5	23,6	C	76
	D													D	
80	C									25,1	23,1	22,2	20,4	C	80
	D													D	
84	C									22,3	20,8	19,4	17,4	C	84
	D													D	
88	C										18,5	17,4	14,6	C	88
	D													D	
92	C											15,4	13,1	C	92
	D													D	
96	C											13,5	11,7	C	96
	D													D	
100	C												10,4	C	100
	D													D	

TAB 128170 / 128171 / 128175 / 128188 / 128189 / 128193

Traglasten am SW-Auslegersystem

Lifting capacities on SW boom/jib combination

Forces de levage en configuration SW



		49 m													
		28 m	35 m	42 m	49 m	56 m	63 m	70 m	77 m	84 m	91 m	98 m	105 m		
14	C	290												D	14
	D	303												D	
16	C	251	244											D	16
	D	275	249											D	
18	C	220	216	207										D	18
	D	236	238											D	
20	C	196	194	187	173									D	20
	D	211	208	200										D	
22	C	176	175	185	169	145	125							D	22
	D	188	186											D	
24	C	159	169	165	163	142	122	105						D	24
	D	169												D	
26	C	145	153	151	149	139	120	104	91					D	26
	D	154												D	
28	C	134	139	139	137	135	118	102	89	76				D	28
	D	140												D	
30	C	123	128	127	127	124	116	101	88	75	64	54		D	30
	D	129												D	
32	C		118	116	117	116	111	100	87	75	63	54	45,5	D	32
	D													D	
34	C		109	108	108	107	104	99	86	74	63	53	45	D	34
	D													D	
36	C		102	101	99	99	97	95	85	73	62	53	44,5	D	36
	D													D	
38	C		95	93	93	92	90	89	83	72	62	52	44	D	38
	D													D	
40	C			87	87	85	84	83	81	71	62	52	44	D	40
	D													D	
44	C			77	76	75	72	72	72	69	60	51	43	D	44
	D													D	
48	C				68	66	64	62	63	61	58	50	42,5	D	48
	D													D	
52	C					59	56	55	54	53	52	49	41,5	D	52
	D													D	
56	C					53	50	49,5	48,5	46,5	45,5	44,5	41	D	56
	D													D	
60	C					45	43,5	43,5	41	39	39	37	37	D	60
	D													D	
64	C					40,5	39	38,5	36,5	34,5	34	32	32	D	64
	D													D	
68	C						35	34	32,5	30,5	29,9	27,7	27,7	D	68
	D													D	
72	C							30,5	28,5	26,9	26,3	24,3	24,3	D	72
	D													D	
76	C							27,5	25,6	23,4	22,8	21,2	21,2	D	76
	D													D	
80	C								22,9	20,7	19,6	18,3	18,3	D	80
	D													D	
84	C								20,3	18,6	16,9	15,5	15,5	D	84
	D													D	
88	C									16,5	15,1	12,9	12,9	D	88
	D													D	
92	C										13,4	11,4	11,4	D	92
	D													D	
96	C										11,8	10,1	10,1	D	96
	D													D	
100	C											8,8	8,8	D	100
	D													D	
104	C											7,6	7,6	D	104
	D													D	

TAB 128170 / 128171 / 128175 / 128188 / 128189 / 128193

Traglasten am SW-Auslegersystem

Lifting capacities on SW boom/jib combination

Forces de levage en configuration SW

m	56 m										63 m					m		
	28 m	35 m	42 m	49 m	56 m	63 m	70 m	77 m	84 m	91 m	98 m	105 m	28 m	35 m	42 m		49 m	56 m
14																		
16	242 259	224											231					
18	215 228	207 216	187										219	194	167			
20	193 203	186 201	181	156									197	187	162	140		
22	174 182	180	176	152	134								176	173	158	136	121	
24	163	163	160	148	130	114	99						158	157	152	133	118	
26	149	148	146	143	127	112	97	83					144	143	141	130	116	
28	136	134	134	131	124	110	95	82	70				132	130	129	126	114	
30	125	124	123	121	119	108	94	81	69	60			121	120	119	117	111	
32	115	115	112	112	110	106	92	80	68	60	50		113	111	109	108	107	
34		106	105	103	103	101	91	79	68	59	49,5	41,5		103	101	100	99	
36		98	97	95	95	94	89	78	67	59	49	41,5		95	94	92	92	
38		92	91	89	88	87	85	77	66	58	48,5	41		89	88	86	86	
40			84	83	81	81	79	75	65	58	48	41			82	81	79	
44			75	73	72	70	69	68	63	56	47	40			72	70	69	
48				65	63	62	59	60	58	55	46	39,5				62	61	
52					56	55	52	52	50	50	45,5	38,5				55	54	
56					50	48	46,5	45,5	43,5	43,5	41,5	37,5					48,5	
60						43,5	41	40,5	38,5	38	36,5	34						
64						39	36,5	36	34	33,5	31,5	29,4						
68							33	31,5	30	29,5	27,3	25						
72								28,4	26,1	25,8	23,7	21,6						
76								25,3	23,3	22,3	20,4	18,8						
80									20,8	19,5	17,2	16,2						
84									18,4	17,3	14,4	13,7						
88										15,2	13	11,3						
92											11,7	9,8						
96											10,4	8,6						
100												7,4						
104												6,3						

TAB 128170 / 128171 / 128175 / 128188 / 128189 / 128193

Hubhöhen am SW-Auslegersystem Lifting heights on SW boom/derrick combination Hauteur de levage en configuration SW

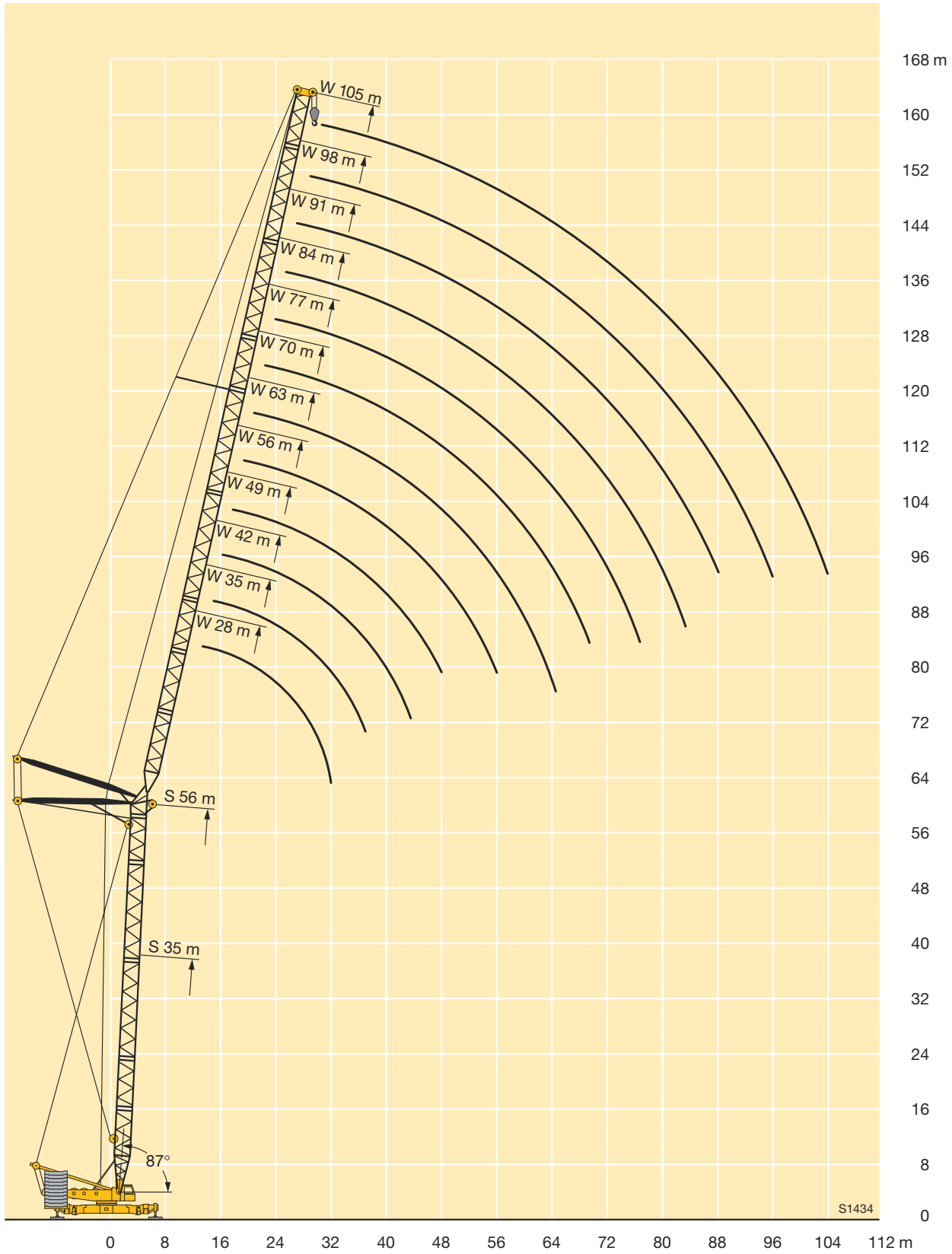

()

Liebherr-Werk Ehingen GmbH

D-89582 Ehingen

☎ +49 73 91 5 02-0, Fax +49 73 91 5 02-33 99

www.liebherr.com, E-mail: info@lwe.liebherr.com

Yuecun Const. Co. Ltd. <http://y6000.co.kr> yccglobal@gmail.com y6000@gmail.com