











()
 Yuekchun Const. Co. Ltd
 TEL +82 22691 6000
 FAX +82 22691 6001
 Web : y6000.co.kr
 E - mail1 : yccglobal@gmail.com
 E - mail2 : y6000@paran.com

24

	SERVICE  → 
	(0) 91 23 95 50 
	(0) 17 18 11 43 24 
	(0) 91 23 18 51 55
	(0) 91 23 18 52 19
	(0) 91 23 30 85
	Service + Spare parts
	e-mail: service@tadanofaun.de
	e-mail: spareparts@tadanofaun.de
	 → ++49

ALL-TERRAIN ATF 60-3

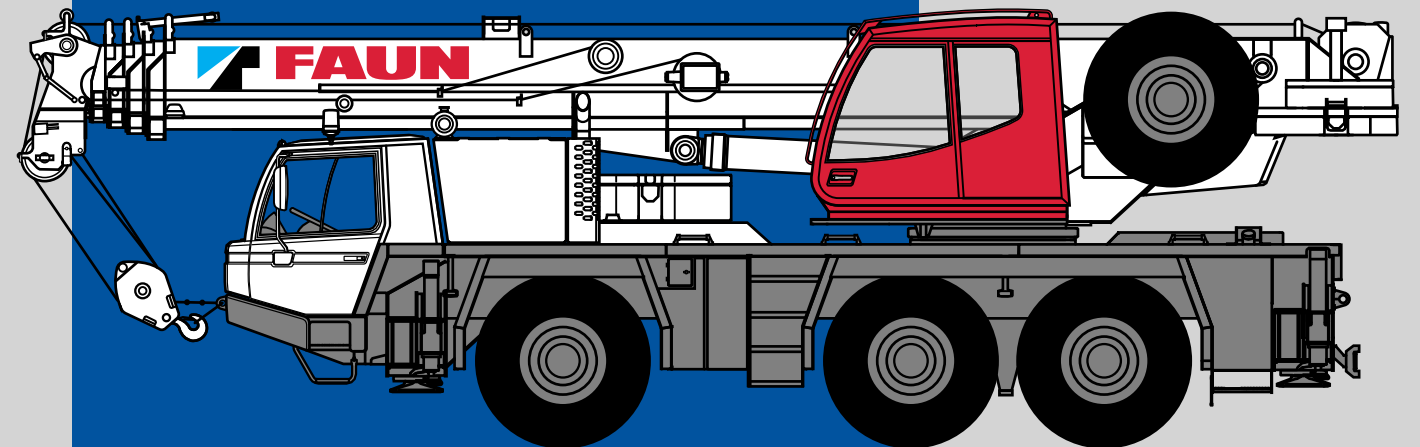

Maße (mm)
 Dimensions (mm)
 Dimensiones (mm)

 16.00 R 25

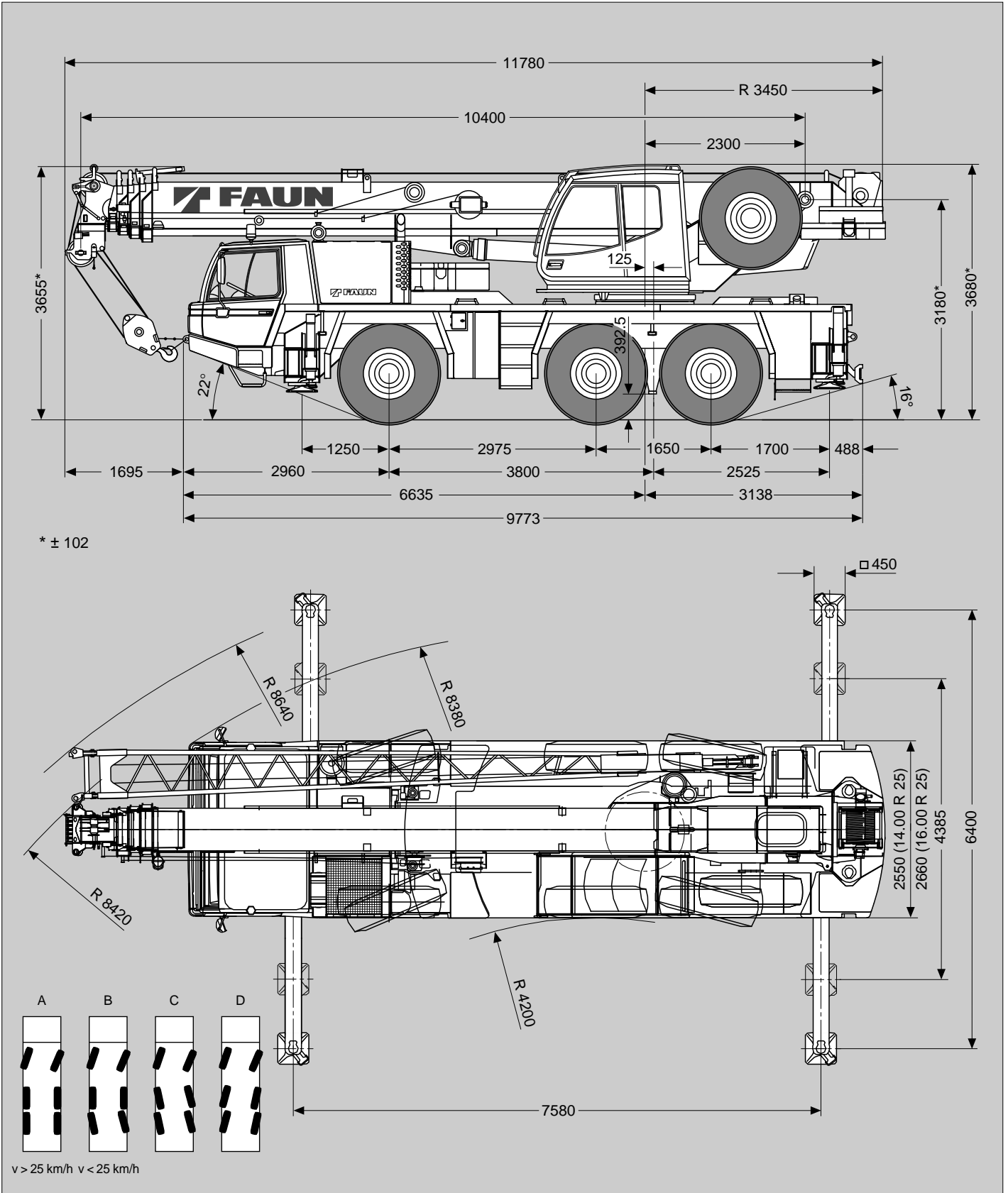

Gewichte / Geschwindigkeiten
Weights / Working speeds
Poids / Vitesses
Pesos / Velocidades de trabajo

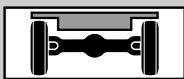
	Achse / Axle Essieu / Eje	1	2	3	Gesamtgewicht / Total weight Poids total / Peso total
	(t)	12	12	12	36*

* Incl. 5,0 t Gegengewicht, 9 m / 16 m Auslegerverlängerung, 32 t Unterflasche, 6 t Hakengeschirr, Antrieb 6 x 6, Bereifung 16.00 R 25.

* Incl. 5.0 t counterweight, 9 m / 16 m boom extension, 32 t hook block, 6 t swivel hook, drive 6 x 6, tyres 16.00 R 25.

* Incl. de 5,0 t contrepoids, 9 m / 16 m fléchette, 32 t moufle, 6 t elingues, entraînement 6 x 6, pneus 16.00 R 25.

* Incl. contrapeso de 5,0 t, 9 m / 16 m plumin, 32 t gancho, 6 t gancho de bola, tracción 6 x 6, neumáticos 16.00 R 25.

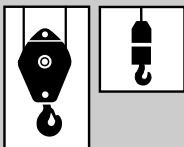
	Traglast / Lifting capacity / Force de levage / Capacidad de elevación	Rollen / Sheaves Pulies / Poleas	Stränge / Parts of line Brins / Ramales de cable	Gewicht / Weight Poid / Peso
	50 t *	5	11	500 kg
50 t	5	11	500 kg	
32 t *	3	7	300 kg	
32 t	3	7	300 kg	
12.5 t	1	3	170 kg	
6 t	-	1	150 kg	



* Doppelhaken



* Rams horn

* Moufle avec crochet marin

* Gancho doble

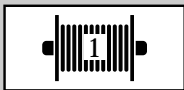
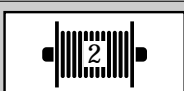
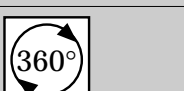
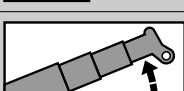

	1	2	3	4	5	6	7	8	9	10	11	12	R1	R2	
	14.00 km/h	5	7	9	11	14	18	24	31	40	52	66	80	6	
16.00 km/h	6	7	10	12	16	20	26	34	44	56	71	80	6	8	59%

V+ 	Stufenlos Infinitely variable Progressivement variable Infinitamente variable	Seil Rope Câble Cable	Max. Seilzug Max. single line pull Effort maxi au brin simple Trio máximo por ramal
	0 - 130 m/min 4. Lage 4 th layer 4 ^{ième} brin capa 4 für einfachen Strang single line au brin simple ramal simple	16 mm / 170 m	52 kN 1. Lage 1 st layer 1 ^{er} brin capa 1
	0 - 130 m/min 4. Lage 4 th layer 4 ^{ième} brin capa 4 für einfachen Strang single line au brin simple ramal simple	16 mm / 170 m	52 kN 1. Lage 1 st layer 1 ^{er} brin capa 1
	0 - 2.5 min ⁻¹ / 0 - 1 min ⁻¹		
	-2° - +82°	ca. 33 s approx. 33 s env. 33 s aproximadamente 33 s	
	10.4 m - 40.2 m	ca. 90 s approx. 90 s env. 90 s aproximadamente 90 s	

Tragfähigkeiten
Lifting capacities
Capacités de levage
Capacidades de elevación

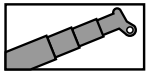

13.2t

DIN/ISO

→ m	10.4 m	14.1 m	17.8 m	21.6 m	25.3 m	29.0 m	32.7 m	36.5 m	40.2 m
2.5	60.0*								
2.5	55.0								
3.0	49.6	30.0							
3.5	45.2	30.0	30.0						
4.0	41.6	30.0	29.0	20.0					
4.5	38.4	30.0	27.6	20.0					
5.0	35.5	30.0	26.2	20.0	17.0				
6.0	30.5	29.2	22.6	18.7	17.0	13.0	13.0		
7.0	26.3	25.5	20.0	17.5	15.8	13.0	13.0		
8.0	17.8	21.0	20.0	16.2	14.5	12.4	13.0	9.0	7.0
9.0		17.1	17.5	14.4	13.3	11.9	12.0	8.8	7.0
10.0		14.3	14.7	12.9	13.0	11.3	11.0	8.5	7.0
11.0		12.1	13.0	11.9	12.6	10.7	10.1	8.3	7.0
12.0			12.0	11.5	11.6	9.7	9.2	8.1	7.0
14.0			9.4	9.5	9.0	8.1	7.8	7.6	6.5
16.0				7.6	7.7	7.0	6.7	6.5	6.1
18.0				6.2	6.4	6.2	5.4	5.8	5.3
20.0					5.4	5.4	4.5	5.0	4.6
22.0					4.5	4.6	4.0	4.1	3.9
24.0						3.9	3.6	3.4	3.2
26.0						3.3	3.2	2.9	2.7
28.0							2.9	2.4	2.2
30.0							2.5	2.0	1.8
32.0								1.6	1.5
34.0								1.3	1.2
36.0									0.9

II	0	50	50 / 100 / 0	100 / 0	50 / 100 / 0	100 / 0	100 / 0	100 / 50	100
III	0	0	50 / 0 / 33	50 / 50	50 / 100 / 66	100 / 83	100 / 100	100 / 100	100
IV	0	0	0 / 0 / 33	0 / 50	50 / 0 / 66	25 / 83	50 / 100	75 / 100	100

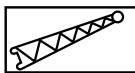
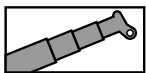

13.2t

DIN/ISO

→ m	36.5 m + 9.0 m			40.2 m + 9.0 m			40.2 m + 16.0 m		
	5°	20°	40°	5°	20°	40°	5°	20°	40°
10	4.8			3.8					
11	4.8			3.8					
12	4.8	3.8		3.8	3.4		2.2		
14	4.6	3.6	2.5	3.8	3.4	2.5	2.2		
16	4.3	3.3	2.4	3.7	3.3	2.5	2.2	1.8	
18	4.1	3.1	2.3	3.6	3.1	2.4	2.1	1.7	1.3
20	3.8	2.9	2.2	3.4	3.0	2.3	2.1	1.7	1.3
22	3.6	2.8	2.1	3.3	2.9	2.2	2.0	1.6	1.2
24	3.2	2.6	2.1	3.0	2.7	2.1	1.9	1.5	1.2
26	2.6	2.5	2.0	2.7	2.6	2.1	1.8	1.5	1.2
28	2.1	2.3	2.0	2.2	2.4	2.0	1.7	1.4	1.1
30	1.7	1.8	1.9	1.8	1.9	2.0	1.6	1.3	1.1
32	1.3	1.4	1.5	1.4	1.5	1.6	1.5	1.2	1.1
34	1.0	1.1	1.1	1.1	1.2	1.3	1.4	1.2	1.0
36	0.7	0.8	0.8	0.8	0.9	1.0	1.3	1.1	1.0
38	0.5	0.5	0.5	0.6	0.6	0.7	1.0	1.1	1.0
40							0.8	0.9	0.9
42							0.6	0.7	0.8
44								0.5	0.6

I	100	100
II	100	100
III	75	100
IV	75	100

Hubhöhen
Lifting heights
Hauteurs de levage
Alturas de elevación

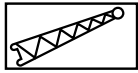
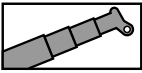

13.2t

DIN/ISO

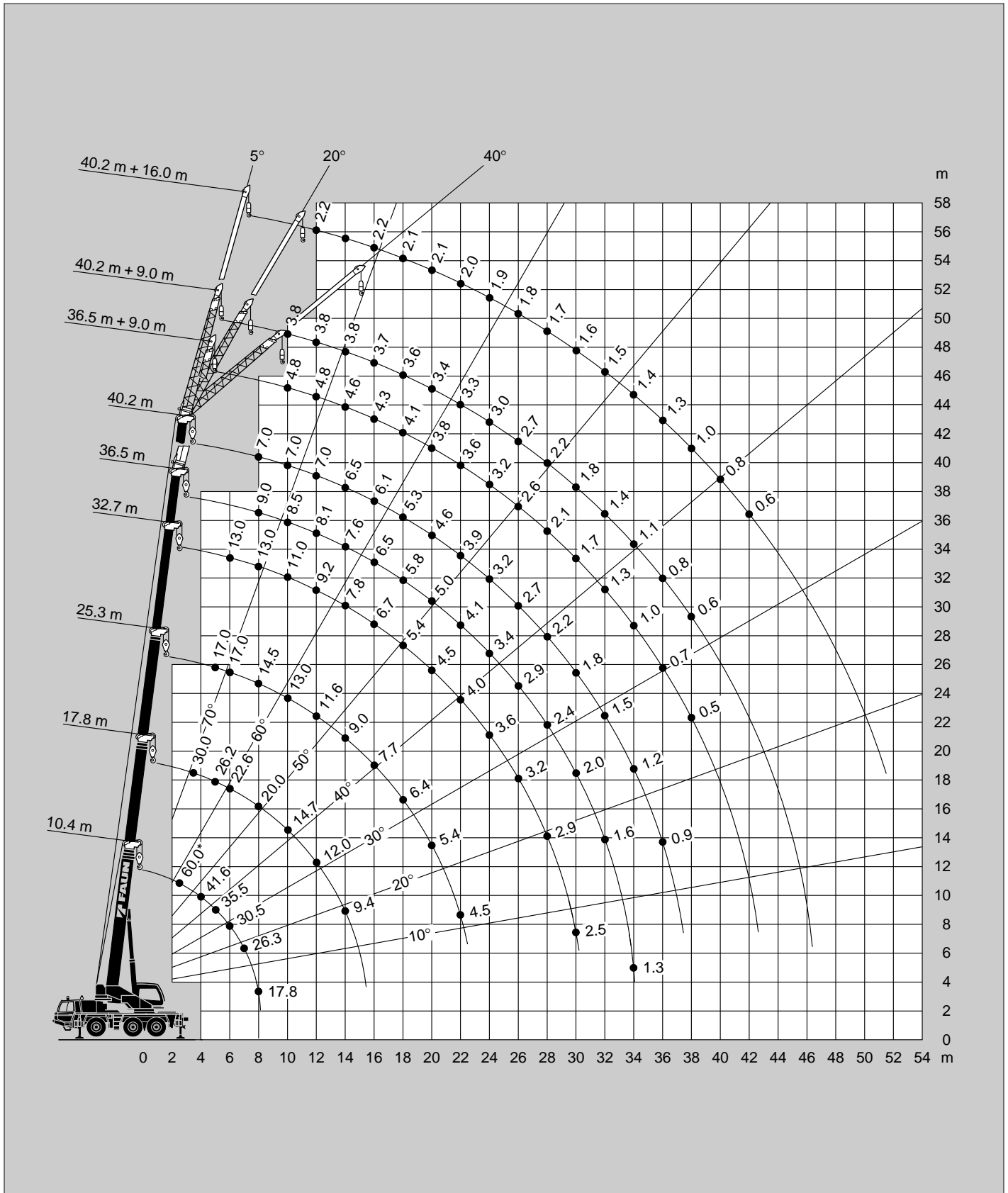

*Nach hinten, mit Zusatzausrüstung / *Over rear, with additional equipment / *A l'arrière, avec équipement supplémentaire / *Sobre la parte trasera, con equipo adicional

Tragfähigkeiten
Lifting capacities
Capacités de levage
Capacidades de elevación

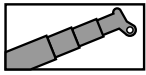

6.1 t

DIN/ISO

 m	10.4 m	14.1 m	17.8 m	21.6 m	25.3 m	29.0 m	32.7 m	36.5 m	40.2 m
2.5	60.0*								
2.5	55.0								
3.0	49.3	30.0							
3.5	45.0	30.0	30.0						
4.0	41.0	30.0	29.0	20.0					
4.5	37.6	30.0	27.6	20.0					
5.0	34.2	30.0	26.2	20.0	17.0				
6.0	27.8	26.6	22.6	18.7	17.0	13.0	13.0		
7.0	20.8	19.8	20.0	17.5	15.8	13.0	13.0		
8.0	16.3	15.4	15.9	15.0	14.5	12.4	13.0	9.0	7.0
9.0		12.4	13.0	12.6	13.0	11.9	12.0	8.8	7.0
10.0		10.2	11.9	12.0	11.5	10.6	11.0	8.5	7.0
11.0		8.5	10.2	10.3	10.5	9.1	9.2	8.3	7.0
12.0			8.8	8.9	9.1	8.5	7.9	8.1	7.0
14.0			6.8	6.8	7.1	7.1	6.7	6.6	6.4
16.0				5.4	5.6	5.6	5.7	5.2	5.0
18.0				4.2	4.4	4.5	4.6	4.0	3.8
20.0					3.6	3.6	3.7	3.2	3.0
22.0					2.9	3.0	3.0	2.5	2.3
24.0						2.4	2.5	1.9	1.8
26.0						2.0	2.0	1.5	1.3
28.0							1.6	1.1	0.9
30.0							1.3	0.8	0.6
32.0								0.5	
34.0									
36.0									

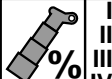
 %	I	II	III	IV
I	0	50	50 / 100 / 0	100 / 0
II	0	0	50 / 0 / 33	50 / 50
III	0	0	0 / 0 / 33	0 / 50
IV	0	0	0 / 0 / 33	0 / 50

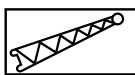
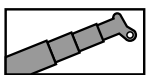

6.1 t

DIN/ISO

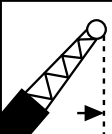
 m	36.5 m + 9.0 m			40.2 m + 9.0 m			40.2 m + 16.0 m		
	5°	20°	40°	5°	20°	40°	5°	20°	40°
10	4.8			3.8					
11	4.8			3.8					
12	4.8	3.8		3.8	3.4		2.2		
14	4.6	3.6	2.5	3.8	3.4	2.5	2.2		
16	4.3	3.3	2.4	3.7	3.3	2.5	2.2	1.8	
18	3.9	3.1	2.3	3.6	3.1	2.4	2.1	1.7	1.3
20	3.0	2.9	2.2	3.1	3.0	2.3	2.1	1.7	1.3
22	2.3	2.5	2.1	2.4	2.6	2.2	2.0	1.6	1.2
24	1.7	1.9	2.1	1.8	2.0	2.1	1.9	1.5	1.2
26	1.2	1.4	1.6	1.3	1.5	1.7	1.8	1.5	1.2
28	0.8	1.0	1.2	0.9	1.1	1.3	1.4	1.4	1.1
30	0.5	0.6	0.8	0.6	0.8	0.9	1.1	1.3	1.1
32						0.5	0.8	1.1	1.1
34							0.5	0.8	1.0
36								0.5	0.7
38									
40									
42									
44									

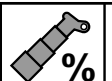
 %	I	II	III	IV
I	100	100	100	100
II	100	100	100	100
III	75	75	100	100
IV	75	75	100	100

Hubhöhen
Lifting heights
Hauteurs de levage
Alturas de elevación

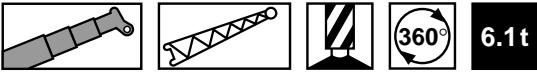

DIN/ISO

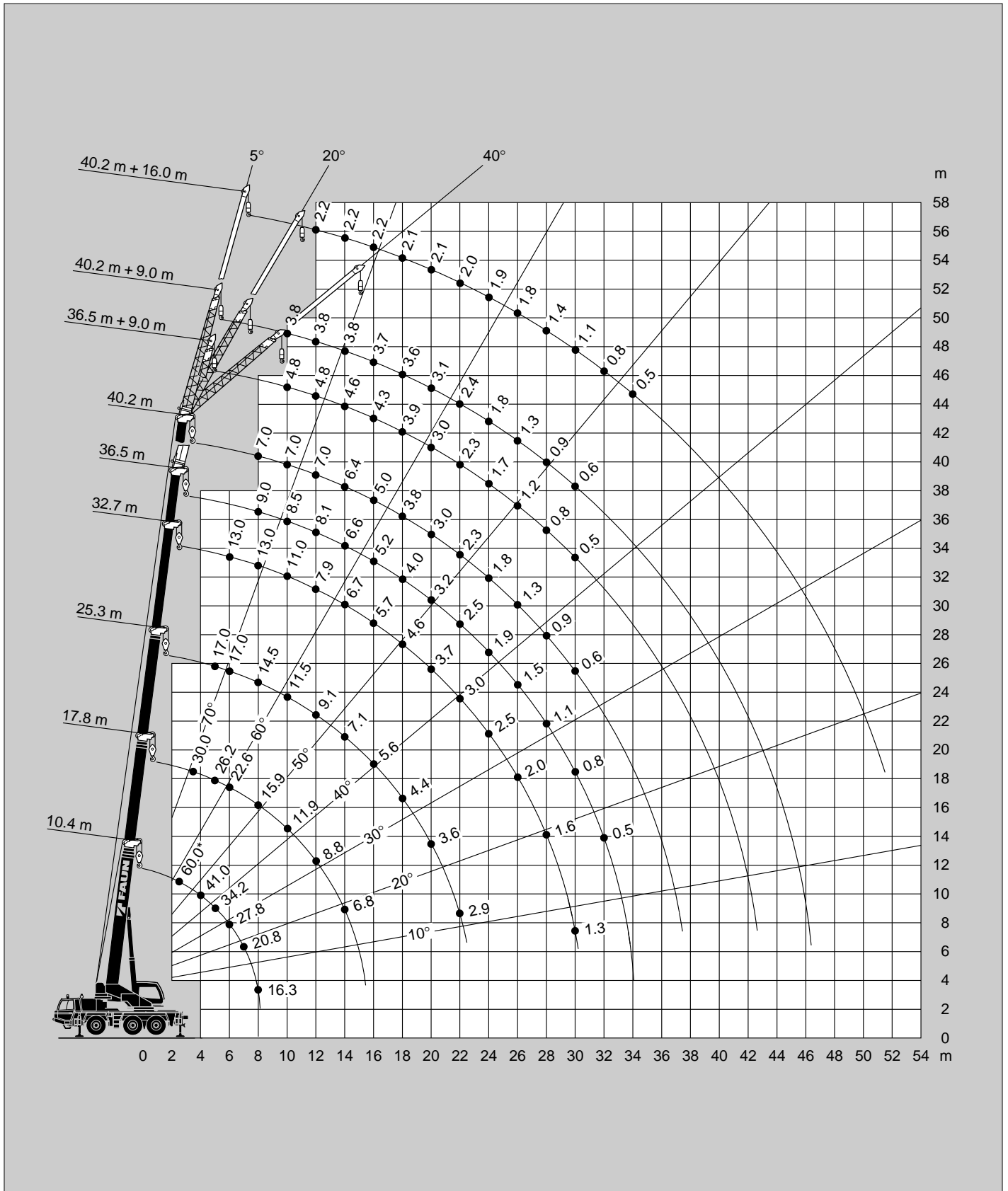

*Nach hinten, mit Zusatzausrüstung / *Over rear, with additional equipment / *A l'arrière, avec équipement supplémentaire / *Sobre la parte trasera, con equipo adicional

Tragfähigkeiten
Lifting capacities
Capacités de levage
Capacidades de elevación

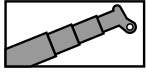

5.0t

DIN/ISO

 m	10.4 m	14.1 m	17.8 m	21.6 m	25.3 m	29.0 m	32.7 m	36.5 m	40.2 m
2.5	60.0*								
2.5	55.0								
3.0	49.3	30.0							
3.5	45.0	30.0	30.0						
4.0	41.0	30.0	29.0	20.0					
4.5	37.6	30.0	27.6	20.0					
5.0	33.7	30.0	26.2	20.0	17.0				
6.0	26.4	25.3	22.6	18.7	17.0	13.0	13.0		
7.0	19.7	18.7	19.2	17.5	15.8	13.0	13.0		
8.0	15.5	14.5	15.0	14.2	14.5	12.4	13.0	9.0	7.0
9.0		11.7	13.0	12.6	13.0	11.9	12.0	8.8	7.0
10.0		9.6	11.3	11.4	11.0	9.9	10.3	8.5	7.0
11.0		8.0	9.6	9.7	9.9	9.1	8.7	8.3	7.0
12.0			8.3	8.4	8.6	8.5	7.4	7.7	7.0
14.0			6.3	6.4	6.6	6.7	6.7	6.2	6.0
16.0				5.0	5.2	5.3	5.3	4.7	4.5
18.0				3.9	4.1	4.2	4.2	3.7	3.5
20.0					3.3	3.3	3.4	2.9	2.7
22.0					2.6	2.7	2.7	2.2	2.0
24.0						2.2	2.2	1.7	1.5
26.0						1.7	1.8	1.3	1.1
28.0							1.4	0.9	0.7
30.0							1.1	0.6	
32.0									
34.0									

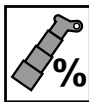

I
II
III
IV

0	50	50 / 100 / 0	100 / 0	50 / 100 / 0	100 / 0	100 / 0	100 / 0	100 / 50	100
0	0	50 / 0 / 33	50 / 50	50 / 100 / 66	100 / 83	100 / 100	100 / 100	100 / 100	100
0	0	0 / 0 / 33	0 / 50	50 / 0 / 66	25 / 83	50 / 100	75 / 100	100	100
0	0	0 / 0 / 33	0 / 50	50 / 0 / 66	25 / 83	50 / 100	75 / 100	100	100

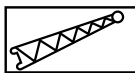
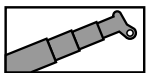

5.0t

DIN/ISO

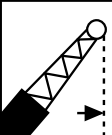
 m	36.5 m + 9.0 m			40.2 m + 9.0 m			40.2 m + 16.0 m		
	5°	20°	40°	5°	20°	40°	5°	20°	40°
10	4.8			3.8					
11	4.8			3.8					
12	4.8	3.8		3.8	3.4		2.2		
14	4.6	3.6	2.5	3.8	3.4	2.5	2.2		
16	4.3	3.3	2.4	3.7	3.3	2.5	2.2	1.8	
18	3.5	3.1	2.3	3.6	3.1	2.4	2.1	1.7	1.3
20	2.7	2.9	2.2	2.8	3.0	2.3	2.1	1.7	1.3
22	2.0	2.3	2.1	2.1	2.4	2.2	2.0	1.6	1.2
24	1.5	1.7	1.9	1.6	1.8	2.0	1.9	1.5	1.2
26	1.0	1.2	1.4	1.1	1.3	1.5	1.6	1.5	1.2
28	0.6	0.8	0.9	0.7	0.9	1.1	1.2	1.4	1.1
30		0.5	0.6		0.6	0.7	0.9	1.2	1.1
32							0.6	0.9	1.1
34								0.6	0.8
36									0.5
38									
40									
42									
44									

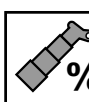

I
II
III
IV

100									100
100									100
75									100
75									100

Hubhöhen
Lifting heights
Hauteurs de levage
Alturas de elevación

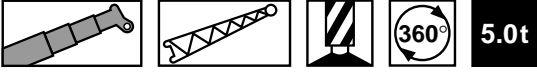



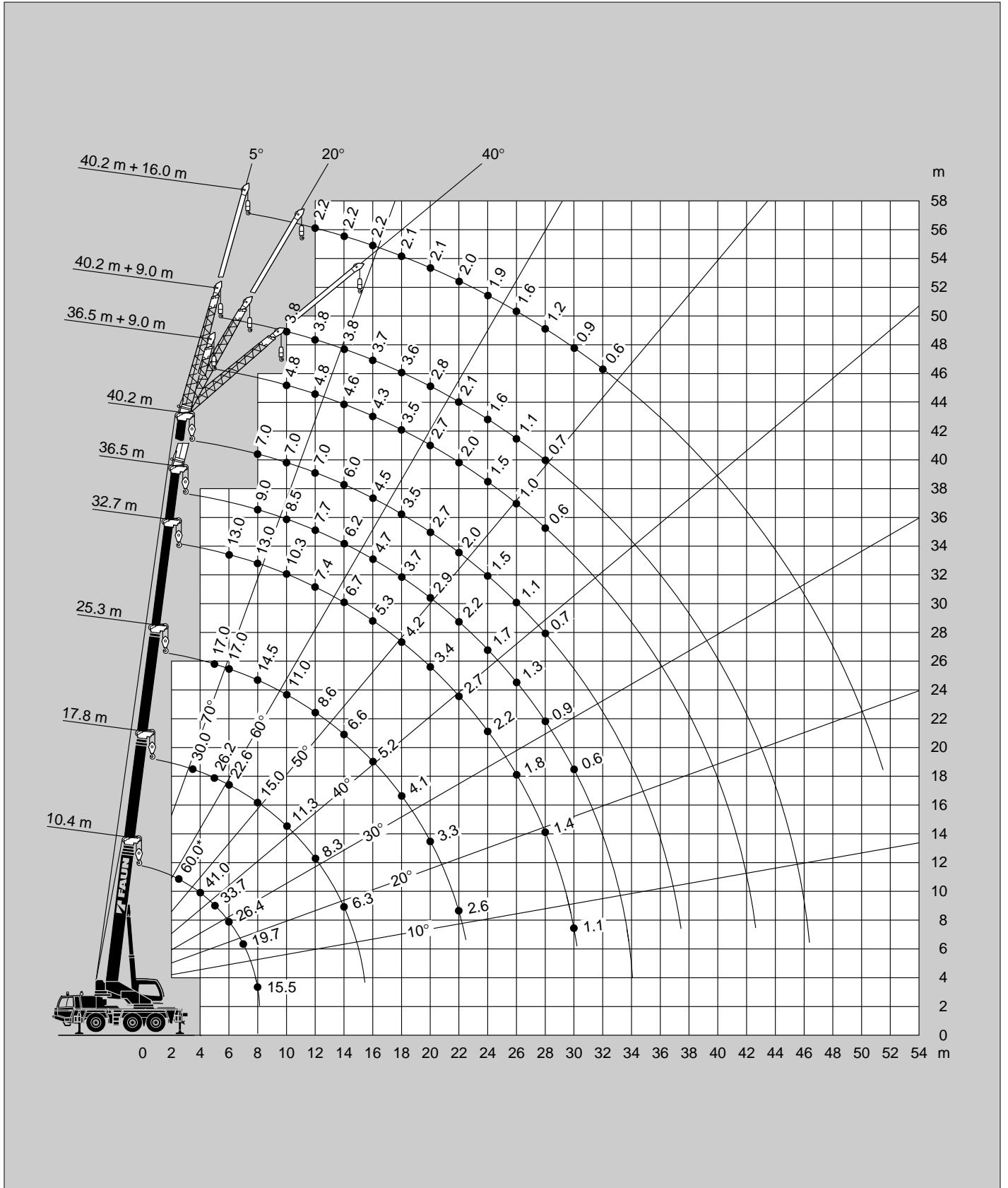



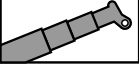

DIN/ISO



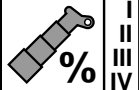

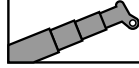



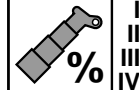

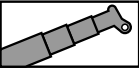
*Nach hinten, mit Zusatzausrüstung / *Over rear, with additional equipment / *A l'arrière, avec équipement supplémentaire / *Sobre la parte trasera, con equipo adicional

Tragfähigkeiten am Teleskopausleger
 Lifting capacities on telescopic boom
 Capacités de levage à la flèche télescopique
 Capacidades de elevación con la pluma telescópica

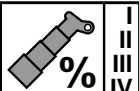
						13.2t	DIN/ISO	
 m	10.4 m	14.1 m	17.8 m					
3.0	12.7	11.3						
3.5	11.4	10.3	10.4					
4.0	10.3	9.5	9.5					
4.5	9.3	8.6	8.7					
5.0	8.5	7.9	8.1					
6.0	7.0	6.5	6.9					
7.0	5.6	5.5	6.0					
8.0	4.4	4.7	5.2					
9.0		4.0	4.5					
10.0		3.4	3.9					
11.0		2.9	3.4					
12.0			3.0					
14.0			2.1					
16.0								
18.0								
20.0								
22.0								
24.0								
26.0								
 %	I	0	50	0				
II	0	0	33					
III	0	0	33					
IV	0	0	33					

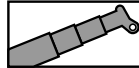
						6.1t	DIN/ISO	
 m	10.4 m	14.1 m	17.8 m					
3.0	12.1	11.0						
3.5	10.9	10.1	10.0					
4.0	9.8	9.0	9.2					
4.5	8.8	8.1	8.5					
5.0	7.9	7.2	7.8					
6.0	5.8	5.4	6.2					
7.0	4.2	4.1	4.9					
8.0	2.8	3.1	4.0					
9.0		2.5	3.2					
10.0		1.9	2.7					
11.0		1.4	2.2					
12.0			1.8					
14.0			1.1					
16.0								
18.0								
20.0								
22.0								
24.0								
26.0								
 %	I	0	50	0				
II	0	0	33					
III	0	0	33					
IV	0	0	33					

						5.0t	DIN/ISO	
 m	10.4 m	14.1 m	17.8 m					
3.0	12.1	11.0						
3.5	11.0	10.1	10.1					
4.0	9.9	9.3	9.3					
4.5	8.6	8.0	8.3					
5.0	7.4	6.7	7.4					
6.0	5.4	5.0	5.8					
7.0	3.9	3.8	4.6					
8.0	2.6	2.8	3.8					
9.0		2.2	3.0					
10.0		1.7	2.5					
11.0		1.3	2.0					
12.0			1.6					
14.0			1.0					
16.0								
18.0								
20.0								
22.0								
24.0								
26.0								
 %	I	0	50	0				
II	0	0	33					
III	0	0	33					
IV	0	0	33					

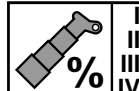
						5.0t	DIN/ISO	
 m	10.4 m	14.1 m	17.8 m					
3.0	11.5	10.6						
3.5	10.4	9.1	9.6					
4.0	8.9	7.8	8.3					
4.5	7.6	6.9	7.3					
5.0	6.6	6.0	6.4					
6.0	4.9	4.3	5.1					
7.0	3.5	2.9	3.9					
8.0	2.4	2.1	3.0					
9.0		1.3	2.4					
10.0		0.9	1.8					
11.0			1.4					
12.0			1.0					
14.0			0.5					
16.0								
18.0								
20.0								
22.0								
24.0								
26.0								
 %	I	0	50	0				
II	0	0	33					
III	0	0	33					
IV	0	0	33					

Anmerkungen zu den Traglasttabellen

Die Tragfähigkeiten im Festigkeitsbereich basieren auf DIN 15018 Blatt 2 und Blatt 3 und F.E.M.

Die Tragfähigkeiten im Standsicherheitsbereich entsprechen DIN 15019 Teil 2 / ISO 4305.

Die zulässige Windgeschwindigkeit beträgt maximal 15 m/sec.

Die Tragfähigkeiten sind in metrischen Tonnen angegeben.

Das Gewicht des Lasthakens bzw. der Hakenflasche und weiterer Anschlagmittel ist von der Tragfähigkeit abzuziehen.

Die Tragfähigkeiten für den Teleskopausleger gelten nur bei demonstrierter Spitze.

Die Ausladung ist der horizontale Abstand von Mitte Drehkranz bis Mitte freihängender, nicht schwingender Last.

Tragfähigkeitsänderungen vorbehalten.

Obige Angaben dienen nur zur Information. Die Bedienungsanleitungen müssen zu Rate gezogen werden, bevor die Maschine in Betrieb genommen wird. Alle hier gemachten Angaben beziehen sich auf die Standard-Ausführung. Jegliche Ausrüstungsveränderungen können die angegebenen Werte beeinflussen.

Remarks relating to the rating charts

The lifting capacities in the structural area are based on DIN 15018 parts 2 and 3 and F.E.M.

The lifting capacities in the stability area are based on DIN 15019 part 2 / ISO 4305.

The maximum permissible wind speed for crane operation is 15 m/sec.

The lifting capacities shown are in metric tons.

The weight of load handling devices such as hook blocks, slings, etc., must be considered as part of the load and must be deducted from the lifting capacities.

The lifting capacities for the telescopic boom apply to a crane with no boom extensions being stowed or mounted on the crane.

The working radius is the horizontal distance from the centre of rotation to the centre of the freely suspended non-oscillating load.

The lifting capacities are subject to change without prior notice.

The above remarks are for basic information only and the operator's manual must be consulted before operating this crane. All data and performances refer to the standard crane. The addition of optional and other equipment may affect the performance of the crane.

Remarques relatives aux tableaux des charges

Les forces de levage sont conformes aux normes DIN 15018, p. 2 et 3, et F.E.M.

Les forces de levage dans la partie de stabilité au renversement sont conformes aux normes DIN 15019, chap. 2 / ISO 4305.

La grue peut travailler aux vitesses de vent allant jusqu'à 15 m/s.

Les forces de levage sont données en tonnes métriques.

Le poids du crochet-moufle et de tous les accessoires d'élingage font partie de la charge et sont à déduire des charges indiquées.

Les forces de levage indiquées pour la flèche télescopique s'entendent fléchette déposée.

Comme portée, on entend la distance horizontale du centre de la couronne de rotation au centre de la charge librement suspendue et non oscillante.

Sauf modification de forces de levage.

Les données ci-dessus servent à titre d'information. Avant la mise en marche de la grue il est conseillé d'étudier les instructions de service. Toutes les données indiquées ci-dessus se réfèrent à la machine de base. Tout changement de l'équipement de la grue peut influencer ces valeurs.

Notas relativas a los graficos de carga

En cuanto a los datos referentes a resistencia, las capacidades de carga están basados sobre las normas DIN 15018, pág. 2 y 3, y F.E.M.

En cuanto a los datos referentes a estabilidad anti-vuelco, las capacidades de carga están basados sobre las normas DIN 15019, Cap. 2 / ISO 4305.

La velocidad anemométrica max. admisible es de 15 m/seg.

Las capacidades de carga indicadas en las tablas corresponden a toneladas métricas.

Hay que deducir los pesos del gancho, eslingas y de otros dispositivos para fijación de cargas de los valores indicados en las tablas.

Las capacidades de carga referentes a la pluma telescópica valen solamente si el plumín está desmontada.

Como alcance se entiende la distancia horizontal desde el centro de la corona de giro hasta el centro de la carga suspendida libremente y no oscilante.

Salvo modificación de capacidades de carga, sin previo aviso.

Los datos arriba indicados sirven solamente para su información. Hay que leer las instrucciones para el uso antes de la puesta en servicio de la máquina. Todos los datos mencionados en las presentes tablas rigen para los modelos standard. Cualquier modificación del equipo montado puede dar lugar a modificaciones de aquellos valores.

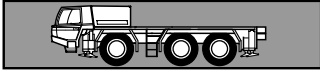

Rahmen Verwindungs- und biegesteife Schweißkonstruktion aus hochfestem Feinkornstahl.

Abstützung 4-Punkt-Abstützung, hydraulisch, Bedienungsmöglichkeiten an beiden Seiten des Fahrgestelles und in der Oberwagenkabine.
Abstützbasis 6,40 m (und 4,38 m) x 7,58 m.

Motor Mercedes-Benz 6-Zylinder-Dieselmotor OM 926 LA (Euromot 2/EPA 2), wassergekühlt, Leistung 240 kW (326 PS) bei 2200 min⁻¹.
Drehmoment 1300 Nm (132,5 kpm) bei 1200 bis 1500 min⁻¹.
Motorleistung nach 80/1269/EWG. Kraftstoffbehälter 350 l.

Getriebe ZF-AS-Tronic 12 AS 2302 mechanisches Schaltgetriebe mit elektronisch-pneumatisch geregelter Trockenkupplung und vollautomatischer Schaltung mit 12 Vorwärts- und 2 Rückwärtsgängen.

Antrieb 6 x 6

Achsen

1. Achse: gelenkt, angetrieben, Differentialsperre quer.
2. Achse: gelenkt, angetrieben, Differentialsperre längs und quer.
3. Achse: gelenkt, angetrieben, Differentialsperre quer.

Achsaufhängung Hydropneumatische Federung mit Niveauregulierung.

Bremsen Druckluft-Zweikreis-Bremsanlage mit ABS-System. Feststellbremse als Federspeicherbremse an der 1. und 2. Achse wirkend. Dauerbremse als Konstantdrosselanlage mit Auspuffklappenbremse.

Räder 6-fach 16.00 R 25

Lenkung ZF-Servocom-Zweikreis-Hydraulenlenkung. Mechanische Lenkung der 1. Achse und Mitlenken der 3. Achse (unter 25 km/h), hydraulisch unterstützt, mit Notlenkpumpe. Lenkung aller Achsen möglich. Hydrostatische Lenkung aller Achsen aus der Oberwagenkabine.

Untewagenkabine Zwei-Mann-Frontfahrerhaus in Stahl-Kunststoff-Verbund-Konstruktion, Sicherheitsverglasung, luftgefederte Sitze und motorabhängige Warmwasserheizung, Kontroll- und Bedienungselemente für den Fahrbetrieb. Tempomat-Funktion.

Elektrische Anlage 24 Volt-Gleichstrom, 2 Batterien. Die elektrische Anlage entspricht der EG-Norm.

Zusatzrüstung (gegen Mehrpreis)
14.00 R 25 / 20.5 R 25 Bereifung, Reserverad, Anhängerkupplung, Zusatzheizung, Motorvorwärmung, Klimaanlage, Wirbelstrombremse, Sonderlackierung und Beschriftung.

Weitere Zusatzrüstung auf Anfrage.

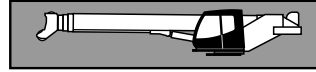

Rahmen Verwindungssteife Schweißkonstruktion mit einer außenverzahnten, einreihigen Kugeldrehverbindung, um 360° unbegrenzt drehbar.

Hydraulik System Diesel-hydraulisch mit 3-Kreis-Hydraulik, 1 leistungsgeregelte Axialkolbendoppelpumpe (hydraulisch verstellbar) und 1 Zahnrad-Doppelpumpe, alle Pumpen vom Unterwagenmotor angetrieben. Bei Kranbetrieb: 200 kW (272 PS) bei 1500 min⁻¹. (DIN 6270B/DIN 6271B).

Steuerung Zwei 4-fach Kreuzsteuerhebel mit hydraulischer Vorsteuerung.

Teleskopausleger Fünfteiliger Teleskopausleger aus hochfestem Feinkornstahl, bestehend aus einem Grundausleger und 4 Teleskopteilen, hydraulisch unter Teillast teleskopierbar. 10,4 m - 40,2 m lang.

Wippwerk Differentialzylinder mit angebautem Senkbremssperrventil.

Hubwerk Axialkolben-Motor, Hubwerkstrommel mit eingebautem Planetengetriebe und federbelasteter Hydro-Lamellenbremse mit integriertem Freilauf beim Heben. Hubseil mit 'Super-Stop' Einrichtung.

Drehwerk Axialkolben-Motor, zweistufiges Planetengetriebe mit fußbetätigter Betriebsbremse und Feststellung. Drehgeschwindigkeit stufenlos von 0 - 2,5 min⁻¹.

Gegengewicht Standard 6,1 t teilbar. Die Bedienung erfolgt aus der Oberwagenkabine.

Oberwagenkabine Großräumige Krankabine in Stahl-Kunststoff-Ausführung mit Sicherheitsverglasung mit getönten Scheiben, kippbarem Arbeitsplatz mit verstellbarem, gefederten gedämpftem Fahrersitz, motorunabhängige Warmluftheizung, Kontroll- und Bedienungselemente für Kranbetrieb, Verfahrbarkeit vom Oberwagen und Abstützbetätigung.

Elektrische Anlage 24 Volt-Gleichstrom.

Sicherheitseinrichtungen Lastmomentbegrenzung (LMB), Arbeitsbereichsanzeige, Hubendschalter, Windenendschalter, Seilwindendrehmelder, Sicherheitsventile gegen Rohr- und Schlauchbrüche. Sperrventile an Hydraulik-Zylindern.

Zusatzrüstung (gegen Mehrpreis)
Auslegerverlängerung 9,0 m / 16,0 m, abwinkelbar 5°, 20° und 40°, Zusatzgegengewicht 7,1 t, verschiedene Unterflaschen, 2. Hubwerk (wie Hauptwinde), Klimaanlage, Arbeitsbereichsbegrenzung, Sonderlackierung und Beschriftung.

Weitere Zusatzrüstung auf Anfrage.

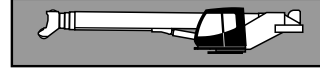
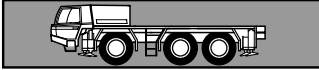

Frame Torsion resistant, welded construction made from high strength, fine-grained steel.

Frame Torsion-resistant, all-welded structure of high strength steel. Connected to carrier by single-row ball-bearing slewing ring with external gearing for 360° continuous rotation.

Outriggers 4 point, telescopic hydraulic outriggers with controls on both sides of carrier and in superstructure cab. Outrigger base 6.40 m (4.38 m mid extension) x 7.58 m.

Hydraulic system Three circuit diesel hydraulic system with 1 power controlled axial piston double pump (hydraulically adjustable) and 1 double gear pump. Pumps driven by carrier engine rated at 200 kW (272 HP) at 1500 min⁻¹ (DIN 6270B/ DIN 6271B).

Carrier engine Mercedes-Benz 6 cylinder model OM 926 LA (Euromot 2/EPA 2), water-cooled diesel engine. Rated at 240 kW (326 HP) at 2200 min⁻¹. Torque 1300 Nm (132.5 kpm) at 1200 - 1500 min⁻¹. Engine rating according to 80/1296/EWG. Fuel tank 350 l.

Controls Hydraulic, 2 joy-stick levers for simultaneous operation of crane motions.

Transmission ZF-AS-Tronic 12 AS 2302 mechanical transmission with electro-pneumatically actuated dry-type clutch and automatic gear shifting with 12 forward gears and 2 reverse gears.

Telescopic boom 5 sections, made of high tensile, fine-grained steel, consisting of 1 base section and 4 telescoping sections. All telescope sections extendable under partial load. 10.4 m to 40.2 m long.

Drive 6 x 6

Derricking system 1 double acting hydraulic cylinder with integral brake and holding valve.

Axles

1st axle: steered, driven.

2nd axle: steered, driven.

3rd axle: steered, driven.

All driven axles with transverse differential locks.

Main winch Axial piston motor, winch drum with integrated planetary reduction and with hydraulically controlled spring-loaded, multiple disc brake and with integrated free rotation (no sagging of load when hoisting). Hoist cable with 'Super-Stop' easy reeving system.

Suspension Hydro-pneumatic with levelling adjustment.

Slewing system Axial piston motor with two-stage planetary reduction with a foot actuated service and a parking brake. Speed infinitely variable 0 - 2.5 min⁻¹.

Brake system Service brakes: dual circuit compressed air system with ABS. Parking brake: spring loaded type acting on 1st and 2nd axles. Auxiliary brakes: engine exhaust brake and constant throttle engine brake system.

Counterweight Standard 6.1 t divisible, assembled and disassembled by hydraulic cylinders controlled from superstructure cab.

Tyres (6) 16.00 R 25.

Steering system ZF Servocom dual circuit hydraulic steering, mechanical hydraulically-assisted steering of 1st axle and 3rd axle (up to 25 km/h), emergency steering pump. Steering of all axles possible. All axles steered hydrostatically from superstructure cab.

Superstructure cab Spacious all-steel panoramic cab with safety (tinted) glass windows, tiltable cockpit with hydraulically cushioned adjustable seat, engine independent hot air heater. Complete controls and instrumentation for crane operation, on-site travelling and outriggers.

Carrier cab Two man full width cab of composite (steel sheet metal and fibre-glass) structure, with safety glass, air-cushioned adjustable seats, engine dependent hot-water heater. Complete controls and instrumentation for road travel. Speed control.

Electrical system 24 volt DC system.

Electrical system 24 volt DC system, 2 batteries. Electrical system conforms with EEC regulations.

Safety devices Load moment device (LMD), working area display, hoist limit switch, lower limit switch, drum turn indicator, safety valves against pipe and hose rupture. Holding valves on hydraulic cylinders.

Optional Equipment (at extra charge)

14.00 R 25/20.5 R 25 tyres, spare wheel and tyre, towing attachment, additional heater, engine pre-heat, air conditioning, eddy current retarder brake, special painting and lettering.

Optional Equipment (at extra charge)

Boom extension 9.0 m / 16.0 m offsets 5°, 20° and 40°, additional counterweight 7.1 t, selection of hook blocks, auxiliary winch (same as main winch) air conditioning, working area limitation, special painting and lettering.

Further optional equipment available upon request.

Further optional equipment available upon request.

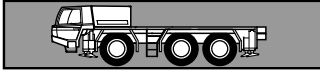

Châssis Construction mécano-soudée, en acier fin, résistante aux flexions et aux torsions.

Calage Calage à 4 points, complètement hydraulique. Commande des stabilisateurs des deux côtés du châssis et de la cabine du grutier. Calage 6,40 m (aussi 4,38 m) x 7,58 m.

Moteur Mercedes-Benz diesel 6 cylindres, modèle OM 926 LA (Euromot 2/EPA 2), refroidi par eau, de 240 kW (326 CV) à 2200 min⁻¹.
Couple: 1300 Nm (132,5 kpm) à 1200 à 1500 min⁻¹.
Puissance selon 80/1296/EWG.
Dépôt de combustible 350 l.

Boîte de vitesse Boîte mécanique ZF-AS-Tronic, modèle 12 AS 2302 avec embrayage électro-pneumatique et boîte automatique, 12 vitesses AV et 2 vitesses AR.

Entraînement 6 x 6

Essieux

- 1^{er} essieu: directeur, entraîné, blocage de différentiel transversal.
- 2^{ème} essieu: directeur, entraîné, blocage de différentiel longitudinal et transversal.
- 3^{ème} essieu: directeur, entraîné, blocage de différentiel transversal.

Suspension Hydro-pneumatique, avec réglage de niveau.

Freins Système à air comprimé, à double circuit, avec système ABS. Frein de stationnement: avec accumulateurs à ressort agissant sur le 1^{er} et 2^{ème} essieu. Frein continu: Frein sur échappement avec étrangleur.

Pneus 6 x 16.00 R 25

Direction Servocom à double circuit, marque ZF. Direction mécanique du 1^{er} essieu, à assistance hydraulique, jusqu'à 25 km/h direction automatique du 3^{ème} essieu, avec pompe de direction auxiliaire. Direction de tous les essieux possible. Direction hydro-statique de tous les essieux depuis la cabine du grutier.

Cabine Cabine bi-place, construction en matière composite fibre de verre et acier. Vitrage en verre de sécurité, sièges à suspension pneumatique. Chauffage à eau chaude relié au moteur. Organes de contrôle et de commande pour la conduite. Régulateur de vitesse.

Système électrique 24 V courant continu, 2 batteries. Conforme aux normes CE.

Équipement supplémentaire (avec supplément de prix)
Pneus 14.00 R 25/20.5 R 25, roue de secours, attache-remorque, chauffage auxiliaire, préchauffage du moteur, climatisation, frein électrique, peinture spéciale et inscription.
Autres équipements supplémentaires sur demande.

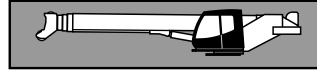

Plate forme Construction mécano-soudée résistante à la torsion. Couronne d'orientation à billes à une rangée, à denture extérieure, permettant une rotation illimitée sur 360°.

Système hydraulique Diesel-hydraulique à 3 circuits, 1 double pompe à pistons axiaux à régulation de puissance (à réglage hydraulique) et 1 pompe à engrenages. Pompes actionnées du moteur châssis. Opération grue: 200 kW (272 CV) à 1500 min⁻¹ selon DIN 6270B/DIN 6271B.

Commande 2 manipulateurs à commande en croix (4 sens), assistés hydrauliquement.

Flèche télescopique 1 flèche de base et 4 éléments télescopiques en acier fin, hydrauliquement télescopable avec charge partielle. Logueur 10,4 m à 40,2 m.

Mécanisme de relevage 1 vérin différentiel muni de clapet de freinage de descente.

Mécanisme de levage Moteur hydraulique, tambour de levage avec boîte planétaire incorporée, frein d'arrêt à disques multiples à ressort, libéré lors du levage. Câble de levage avec dispositif 'Super-Stop'.

Orientation Moteur hydraulique avec entraînement planétaire à 2 gammes. Frein de service actionné par l'intermédiaire d'une pédale et frein de stationnement. Vitesse de rotation 0 à 2,5 min⁻¹ en continu.

Contrepoids Standard 6,1 t divisible, commandé de la cabine du grutier.

Cabine du grutier Cabine de grue spacieuse, construction en matière combinée acier/synthétique, avec vitrage de sécurité en verre teinté, siège réglable et amorti hydrauliquement, inclinable avec instruments de commande, chauffage à air chaud, indépendant du moteur, éléments de commande et de contrôle pour travaux sur chantier, conduite et calage de la grue depuis la cabine du grutier.

Système électrique 24 V courant continu.

Dispositifs de sécurité Limiteur de charge (CEC), indicateur de portée, interrupteur de fin de course de levage et de treuil, indicateur du nombre de tours, soupapes de sécurité contre ruptures des conduites et flexibles, clapets sur vérins hydrauliques.

Équipement supplémentaire (avec supplément de prix)
Fléchette 9,0 m / 16,0 m, inclinable à 5°, 20° et 40°, contrepoids additionnel de 7,1 t, sélection de mouffles, 2^{ème} treuil de levage (identique au treuil principale), climatisation, limiteur de portée, peinture spéciale et inscription.

Autres équipements supplémentaires sur demande.

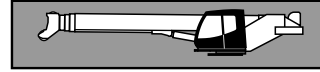
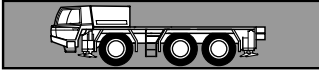

Chasis portante Construcción de acero de alta resistencia soldado, resistente a la torsión y a la flexión.

Estabilizadores Estabilizadores hidráulicos de 4 puntos. Posibilidad de manejo desde ambos lados del chasis portante y desde la cabina de la grúa. Extensión de los estabilizadores: 6,40 m (y 4,38 m) x 7,58 m.

Motor Mercedes-Benz modelo OM 926 LA (Euromot 2/EPA 2), 6 cilindros, diesel, refrigerado por agua. Nominal 240 kW (326 HP) a 2200 min⁻¹. Par 1300 Nm (132,5 kpm) a 1200 hasta 1500 min⁻¹. Potencia del motor según 80/1269/EWG. Réservoir à carburant 350 l.

Transmisión Transmisión mecánica ZF tipo AS-Tronic modelo 12 AS 2302, con 12 marchas adelante y dos marchas atrás, controladas electro - neumáticamente con embrague en seco.

Tracción 6 x 6

Ejes

- 1º eje: de dirección, accionado, con bloqueo diferencial transversal.
- 2º eje: de dirección, accionado, con bloqueo diferencial transversal y longitudinal.
- 3º eje: de dirección, accionado, con bloqueo diferencial transversal.

Suspensión Suspensión hidroneumática con regulación de nivel.

Sistemas de frenos Accionamiento neumático de doble circuito con sistema anti bloqueo ABS. Freno de estacionamiento del tipo muelles cargados, liberados por aire, sobre los ejes 1º y 2º. Freno continuo: sistema estrangulador constante y freno tipo estrangulación sobre el escape del motor diesel.

Neumáticos 6 x 16.00 R 25

Dirección Hidráulica ZF Servocom de doble circuito. Giro mecánico sobre el 1º eje, asistido hidráulicamente. Hasta 25 km/h dirección automática del 3º eje. Bomba hidráulica de emergencia accionada por la transmisión. Dirección de todos los ejes posible. Desde la cabina de la superestructura: dirección hidro-estática de ambos ejes.

Cabina Cabina para dos personas, en construcción de acero y fibra de vidrio. Cristales de seguridad, asiento con suspensión neumática, calefacción por agua caliente del motor. Elementos de control e instrumentos para circulación por carretera. Regulador de velocidad.

Sistema eléctrico Sistema de 24 V c.c. con 2 baterías. El sistema eléctrico cumple la normativa CEE.

Equipo adicional (con suplemento de precio) Neumáticos 14.00 R 25/20.5 R 25, rueda de repuesto, embrague de remolque, calefacción adicional, precalefacción del motor, climatización, freno eléctrico, pintura especial e inscripción.

Otros equipamientos sobre demanda.

Superestructura Construida en aceros soldados, resistente a la torsión. Corona de giro con rodamiento de una fila de bolas con dientes externos para giro continuo de 360°.

Sistema hidráulico Sistema hidráulico de 3 circuitos, 1 bomba doble de pistones axiales de caudal variable (regulable hidráulicamente) y una bomba de engranajes. Las bombas están accionadas desde el motor del chasis. Operación de la grúa: 200 kW (272 HP) a 1500 min⁻¹. (DIN 6270B/DIN 6271B).

Mandos 2 palancas de control de tipo joy-stick para movimientos simultáneos de la grúa (4 direcciones), asistidos hidráulicamente.

Pluma telescópica 5 secciones, un tramo base y 4 telescópicos de acero de alta resistencia soldado, los tramos se pueden telescopar hidráulicamente bajo carga. Longitud de 10,4 m a 40,2 m.

Elevación de pluma Mediante un cilindro hidráulico con válvula de retención integrada.

Cabrestante principal Motor hidráulico de pistones axiales. Tambor del cabrestante con reducción planetaria y frenos de disco múltiples accionado, con sistema libre de elevación. Cable de elevación con sistema de enhebrado fácil y 'Super-Stop'.

Sistema de giro Motor hidráulico de pistones axiales con reducción planetaria de dos etapas. Freno de servicio controlado por pedal y freno de estacionamiento. Velocidad de giro variable de 0 a 2,5 min⁻¹.

Contrapeso Peso total de 6,1 t divisible, accionado desde la cabina de la grúa.

Cabina de la grúa Cabina espaciosa y confortable, en construcción de acero y fibra de vidrio, con cristales coloreados de seguridad. Asiento del operador regulable amortiguado hidráulicamente, inclinable junto con los instrumentos y mandos, calefacción de aire caliente independiente del motor. Controles, instrumentos y mandos de conducción para la operación de la grúa y para el desplazamiento en obra. Mandos para nivelación y extensión de los estabilizadores.

Sistema eléctrico Sistema de 24 V c.c.

Medidas de seguridad Limitación del momento de carga (LMC), limitación del área de trabajo, interruptor de final de elevación, interruptor de 3 últimas vueltas en cabrestante, indicador de bajada o subida del cable del cabrestante, válvulas de seguridad para rotura de tubos y latiguillos. Válvulas de retención en los cilindros hidráulicos.

Equipo adicional (con suplemento de precio) Plumín 9,0 m / 16,0 m, acodable en 5°, 20° y 40°, contrapeso suplementario de 7,1 t, selección de ganchos, segundo cabrestante (igual que cabrestante principal), climatización, limitación del área de trabajo, pintura especial e inscripción.

Otros equipamientos sobre demanda.

Symbolerklärung Symbols Glossaire des symboles Glosario de simbolos

	Siehe Seite 11 As on Page 11 Voyez la page 11 Véase la pagina 11
	Abstützung Outriggers Calage Estabilizadores
	Getriebe / Gang Transmission / Gear Boîte de vitesse / Rapport Transmisión / Marchas
	Achslast Axle load Charge à l'essieu Carga por eje
	Räder / Größe Tyres / Size Pneus / Largeur Neumáticos / Tamaño de ruedas
	Geschwindigkeiten Speeds Vitesses Velocidades
	Steigfähigkeit Gradeability Abtitude en pente Superacion de pendientes
	Drehwerk Slewing system Orientation Sistema de giro
	Gegengewicht Counterweight Contrepoids Contrapeso

	Teleskopausleger Telescopic boom Flèche télescopique Pluma telescópica
	Teleskopieren Boom telescoping Télescopage de flèche Telescopaje de pluma
	Teleskopieren in % Boom telescoping in % Télescopage de flèche en % Telescopaje de pluma en %
	Wippwerk Derricking system Mécanisme de relevage Elevación de pluma
	Ausladung Radius Portée Radio
	Auslegerverlängerung Boom extension Fléchette Plumín
	Ausladung Radius Portée Radio
	Hubwerk Main winch Mécanisme de levage Cabrestante principal
	2. Hubwerk Auxiliary winch 2ème treuil de levage 2º cabrestante
	Unterflasche / Hakengeschrir Hook block / Swivel hook Moufle / Elingues Gancho / Gancho de bola

Notizen
Notes
Notas

